



MODULAR METAL FABRICATORS INC.

Serving the HVAC & Roofing Industries Since 1970.



Modular Metal Fabricators, Inc.

•
24600 Nandina Ave.
Moreno Valley, CA
92551

•
Phone:
(951) 242-3154

•
Fax:
(951) 242-8100

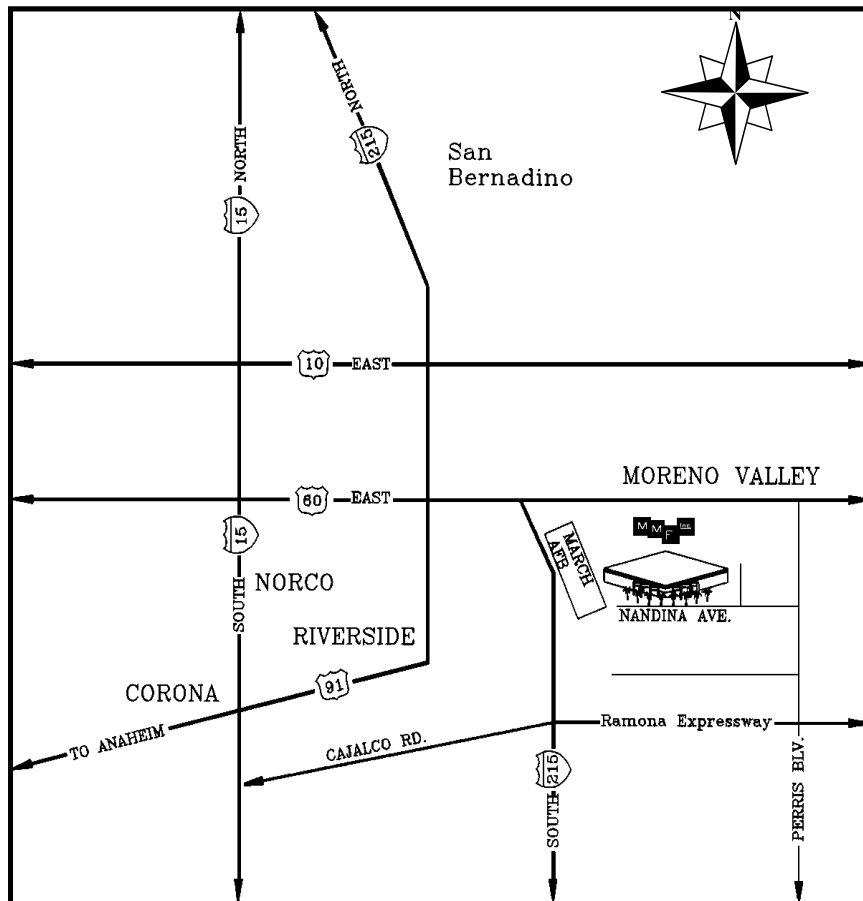

7/1/09



MODULAR METAL FABRICATORS INC.

Modular Metal Fabricators, Inc. established in 1970, specializes in supplying high quality, competitively priced, sheet metal fittings and duct work to the heating, ventilation, air conditioning and roofing industries. Low overhead levels and high volume production methods are used to maintain a high level of customer service. Most standard sizes used in residential applications are stocked at the factory to keep delivery lead time to a minimum. While this catalogue accurately represents the standard product line, MMF, Inc. has a great amount of manufacturing versatility. If you don't see it -- Ask.

Modular Metal Fabricators, Inc. reserves the right to change the sizes it stocks as manufacturing or packaging procedures improve.

Buyer assumes the responsibility for the acceptance of this material at ordinance levels, as codes and specifications can vary in different localities. All products are F.O.B. factory unless specified otherwise.

Claims for shortages or damaged materials must be submitted to MMF, Inc. shipping department within 48 hours of receipt of material. Non stock merchandise is not returnable. Requests for return of stock merchandise must be approved by Modular Metal Fabricators, Inc. in advance. All returns are subject to 15% re-stocking charge.

All prices, terms and delivery lead times are subject to change without notice.

For products not shown in this catalogue call for quote. Orders for non-stock products may be subject to a \$25.00 net pattern charge.

MMF, INC. GAUGE STANDARD

UNLESS OTHERWISE SPECIFIED:

4" THROUGH 12"	30 GAUGE
14" THROUGH 18"	28 GAUGE
20"	26 GAUGE
22" THROUGH 26"	24 GAUGE

Non-stock items require either 5 or 7 working days depending upon item ordered.

Please call for price quotes
on gauges not shown in the
catalog.

7/1/09



MODULAR METAL FABRICATORS INC.

Our valued customer:

Thank you for your interest in our HVAC and roofing products. We are a manufacturer of heating/air conditioning pipe, fittings and roofing products for the HVAC and roofing industry for over 30 years.

As a customer of Modular Metals, you are assured of quality service and quality fittings. Our flexible aluminum pipes, both standard and compressed, are UL LISTED.

Our Modular Flex Duct is also UL LISTED. We have enclosed information that you will find invaluable in ordering our products.

Our helpful personnel will direct you to the person best suited to assist you with your individual need, whether it is placing orders, when your load will arrive, or pricing not shown in our catalogue.

We manufacture many products not shown in our current catalogue. Most of our products are manufactured in 30 through 22 gauge. Our lead time is 3-5 working days for stock, 5-7 working days for non stock, depending on the products.

Should you need an item not shown in our catalogue, please call us, and we will be happy to price this item(s) for you. We are here to serve you in a manner in which you will have the product on your shelf, when your customer needs it.

Our standard terms are net 30. Please call us for your freight terms. Our will call/freight allowance is 3%.

We offer a unique service to you, the customer, in that you can mix various types of products. We do not insist that you order a certain amount of flex to get the competitive pricing we offer, as long as you meet your freight terms in net dollars with mix loads. We are loyal to our customers. We ask that our customers be loyal to us in return, and purchase as many products from us as they can.

We feel, with this program, that you have the opportunity of keeping your inventory at the level needed to service your accounts, and get faster turns on your inventory -- which is what we all strive for.

Again thank you, and we are looking forward to a successful business relationship for both of us. Do not hesitate to call at any time.

Thank You,

MMF, Inc.

7/1/09



MODULAR METAL FABRICATORS INC.

CONDITIONS OF SALE

1. All prices, unless otherwise stated/arranged with Modular Metal Fabricators, Inc. are F.O.B. factory.
2. Packaging standards are set by Modular Metal Fabricators, Inc., unless otherwise stated/arranged/verified by Modular Metal Fabricators, Inc.
3. MMF, Inc. reserves the right to change, improve or modify its products at anytime, and reserves the right to make changes in its catalogue/pricing without prior notice.
4. Special orders (non-stock) cannot be canceled after manufacturing begins.
5. Stock orders canceled will be at no charge, providing the material has not been staged, loaded or delivered. Cancellation after stock orders have been staged, loaded or delivered, are subject to a 15% restocking charge.

DAMAGED / SHORTAGE OF PRODUCTS

1. Damaged/shortage of products must be reported to MMF, Inc. immediately upon receipt of product.
2. Freight damage/shortage of product will not constitute right for buyer to withhold payment from Modular Metal Fabricators, Inc.

ADDITIONS / MINOR CHANGES TO PRODUCTION STOCK ORDERS

1. Changes or additions can be made to the original order, within 24 hours, but may cause a delay to the original order. Changes or additions made after 24 hours, may result in re-scheduling the delivery of the order, by MMF, Inc..

C.O.D. POLICY

1. C.O.D. orders for non stock products must be paid in full prior to production. If delivery is made and payment is not received by driver prior to unloading of products, order will be subject to re-delivery charges at \$1.50 per mile round trip.

7/1/09



MODULAR METAL FABRICATORS INC.

ACCEPTANCE OF ORDERS / SHIPMENT

1. Acceptance of orders/ shipments of product is subject to approval of Modular Metal Fabricators' credit department. MMF, Inc. will not be liable for any delay in the shipment of product by causes beyond its control.
2. Buyer must provide adequate storage for material. Buyer assumes responsibility for any loss of material/damage and or theft once it has been delivered to said buyer.

Claims for damage or shortages.

Claims for shortages or damaged materials must be submitted to MMF, Inc. shipping department within 48 hours of receipt of material. Non stock merchandise is not returnable. Requests for return of stock merchandise must be approved by Modular Metal Fabricators, Inc. in advance. All returns are subject to 15% re-stocking charge.

7/1/09



MODULAR METAL FABRICATORS INC.

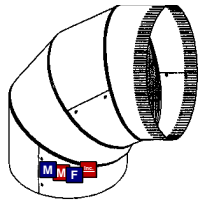

90° Elbows
Page 1A

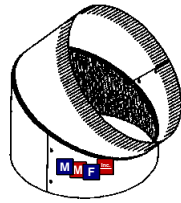

45° Elbows
Page 2A

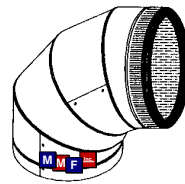

90° Circle Lined
Page 3A

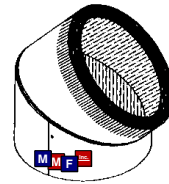

45° Circle Lined
Page 4A

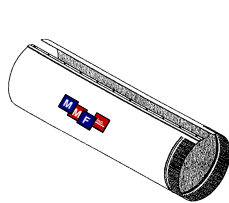

Button-lock Pipe
Page 5A, 6A

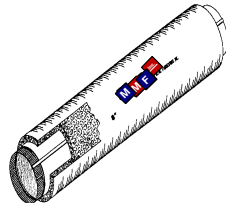

Button-lock Pipe
Page 6A

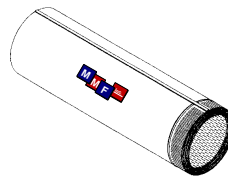

Circle Lined Pipe
Page 7A

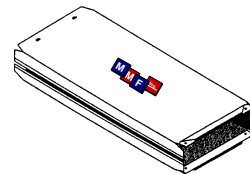

Riser Pipe
Page 8A

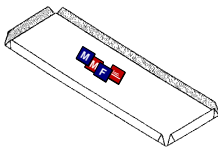

Riser/Perimeter Cap
Page 8A

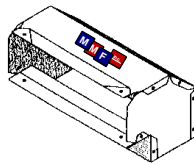

90° Riser Elbow
Page 9A

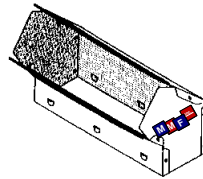

45° Riser Elbow
Page 9A

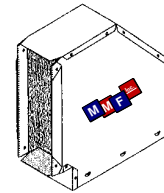

Riser Elbow 90/45° Flat
Page 9A

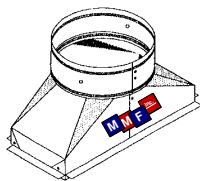

Floor Box 30ga
Page 10A

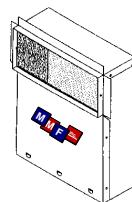

Register Box 30ga
Page 10A

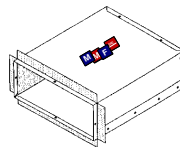

Soffit Box 30ga
Page 10A

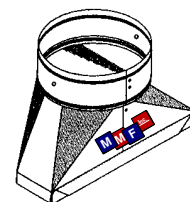

Straight Boot 30ga
Page 11A

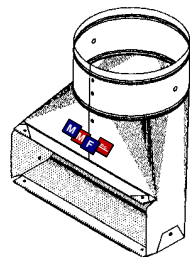

**Stack Head
Boot 30ga**
Page 11A

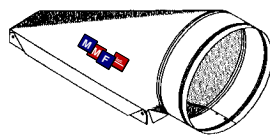

Cone Boot 30ga
Page 11A

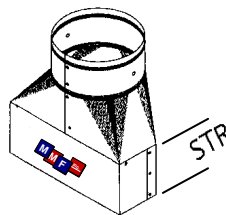

**Perimeter Straight
Boot 30ga PH-1**
Page 12A

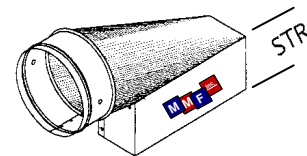

**Perimeter Cone
Boot 30ga PH-2**
Page 12A

7/1/09

PIC01



MODULAR METAL FABRICATORS INC.

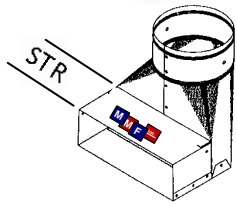

Perimeter Stackhead
Boot 30ga PH-3
Page 12A

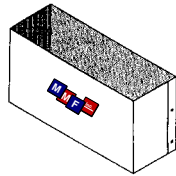

Perimeter Extension
4' and 6' 30ga
Page 13A

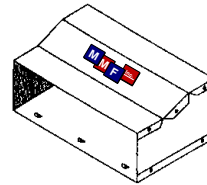

Perimeter Adapter
6' High 30ga
Page 13A

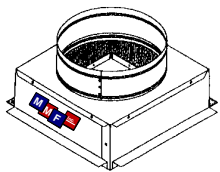

Square Ceiling Box
Page 14A

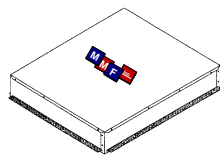

Square Ceiling Box
Page 14A

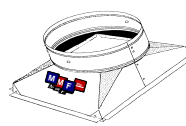

Tapered Ceiling
Page 14AA

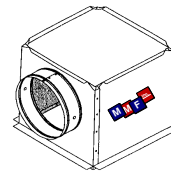

Side Inlet
Page 15A

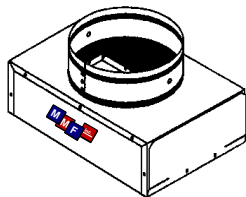

C-Boxes 30ga
Page 15A

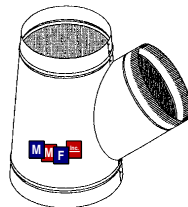

Stock/Non-Stock Wyes
Page 16A, 17A

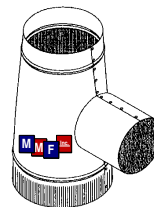

Vent Tees 26ga
Page 17A

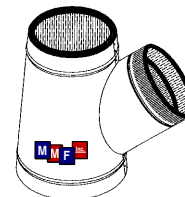

Circle Lined Wye
Page 18A

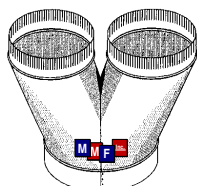

Pant Wye 90°/90°
Page 19A

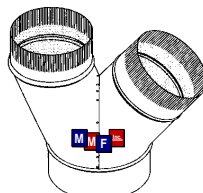

Pant Wye 90°/45°
Page 19A

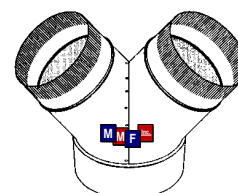

Pant Wye 45°/45°
Page 20A

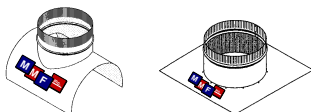

90° Saddle Tap/Flat
Page 21A

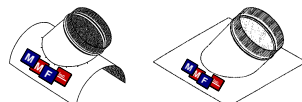

45° Saddle Tap/flat
Page 21A

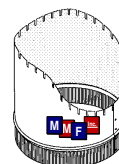

WYE Branches
Page 21A

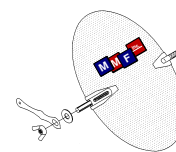

Dampers
Page 22A

7/1/09

PIC05



MODULAR METAL FABRICATORS INC.

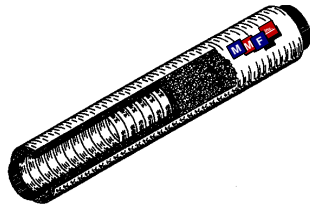

25' Modular Flex Duct
Page 31A

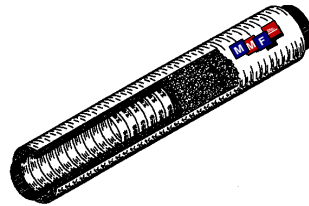

6' Modular Flex Duct
Page 31AA

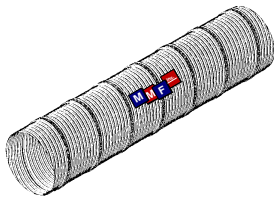

Aluminum Flex
Page 33A

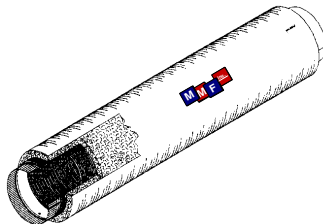

Aluminum Flexible Air Duct
Page 33A

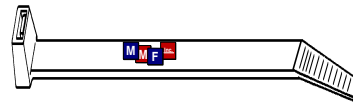

Duct Clamp & Tool
Page 34A

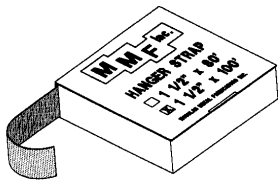

Hanger Strap Galv.
Page 35A

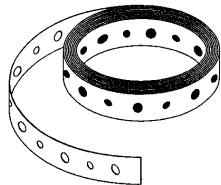

Plumbers Tape
Page 35A

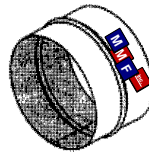

Universal Connector
Page 36A

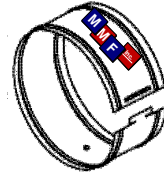

Duct Connector
Page 36A

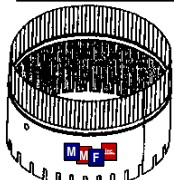

Start Collars
Page 37A

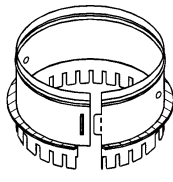

Duct Board
Page 38A



SuperSeal
Page 38AA

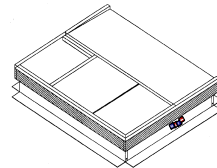

Curbs
Page 39A

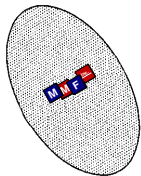

Damper Disc -----
Page 40A

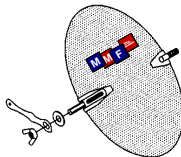

With Hardware
Page 40A

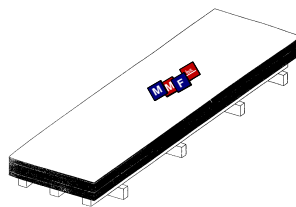

Galv. Metal Sheets
Page 41A



Galv. Hardware Cloth
Page 41A

7/1/09

PIC10



MODULAR METAL FABRICATORS INC.

One Series



SM-1C



SM-1D



SM-1E



SM-1DEL

Two Series

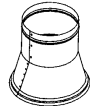

SM-2C



SM-2D



SM-2EL



SM-2DEL

Sheet Metal Spin-Ins Page 1B

ONE SERIES

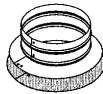

DB-1C



DB-1D



DB-1EL



DB-1DEL

TWO SERIES

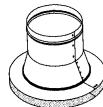

DB-2C



DB-2D



DB-2EL



DB-2DEL

Duct Board Spin-Ins Page 2B

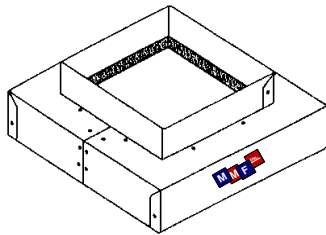

Square To Square Transition
Page 3B

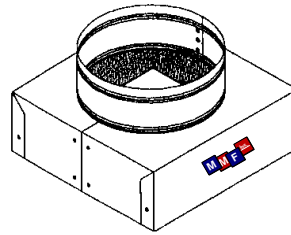

Round Neck Adapters
Page 3B

7/1/09

PIC12



MODULAR METAL FABRICATORS INC.

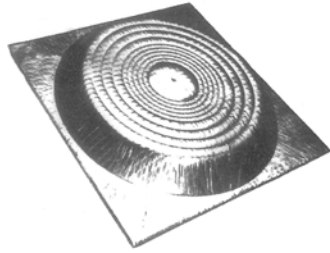

**Perforated Diffuser
Molded Fiberglass Back
Page 4B**

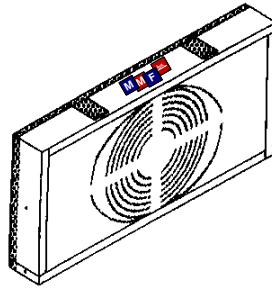

**Perforated Diffuser
Steel Frame Fiberglass Back
Page 4B**

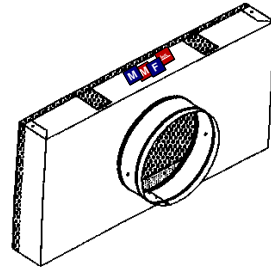

**Perforated Diffuser
Steel Frame & Back
Page 4B**

Face or Grills Only

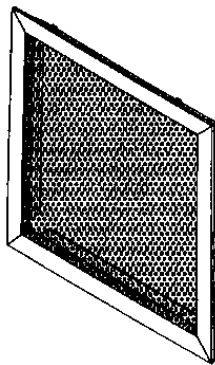

**Filter Grill (PDF)
Page 4B**

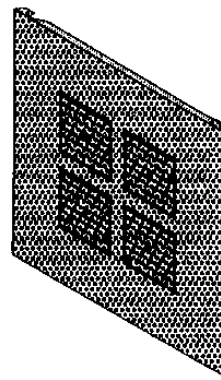

**Supply Grill (PDS)
Page 4B**

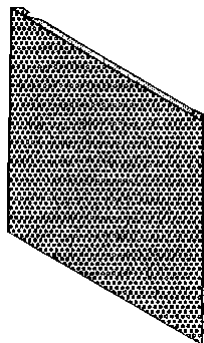

**Return Grill (PDR)
Page 4B**

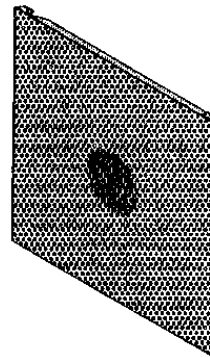

**Universal Grill (PDU)
Page 4B**

7/1/09

PIC15



MODULAR METAL FABRICATORS INC.

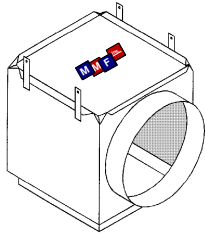

Cushion Head Outlet
Page 5B

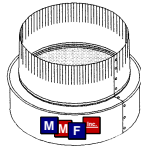

Pancake Taper
Page 5B

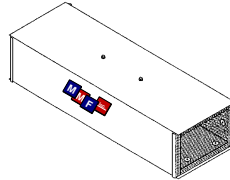

Single Duct - Attenuator - Double Duct
Page 6B / 7B

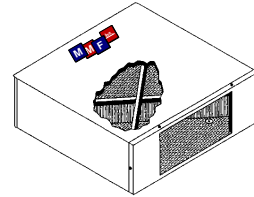

Page 6B / 7B

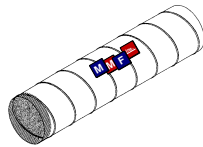

Galv. Spiro Pipe
Page 13B

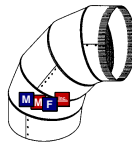

90° 1 1/2 Radius
Page 14B

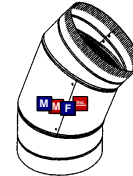

45° 1 1/2 Radius
Page 14B

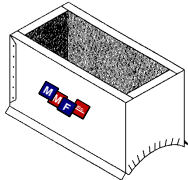

Saddle Tap w/Flange
Page 15B

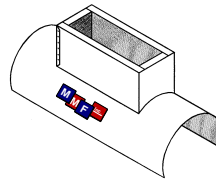

Saddle Tap w/Skirt
Page 15B

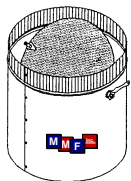

Sleeve w/Damper
Page 17B

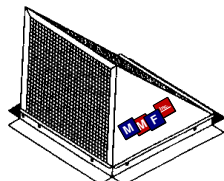

Eyebrow Cap
Page 1C

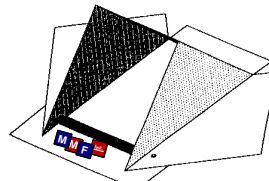

Refrigeration Eyebrow
Page 1C

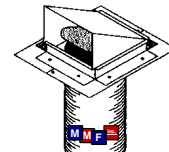

Dryer Vent
Page 2C

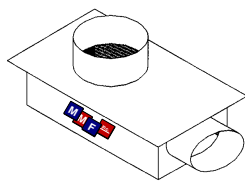

Sproul Dryer Vent
Page 2C

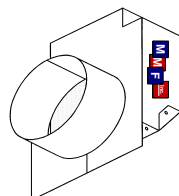

Bliss Dryer Vent
Page 2C

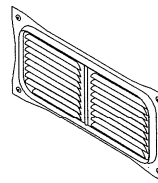

STAMPED

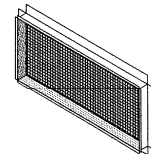

STUCCO

Foundation Vents
Page 3C

7/1/09

PIC20



MODULAR METAL FABRICATORS INC.

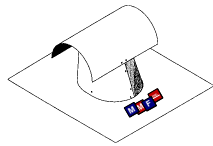

T-Top 28ga Galv.
Page 4C

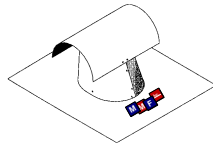

28ga Bonderized
Page 4C

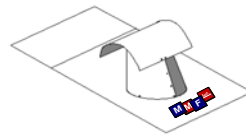

28ga Shake Base
Page 4C

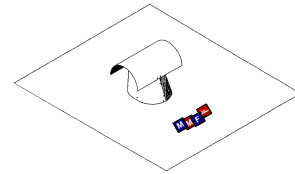

Dead Soft Aluminum
Page 5C

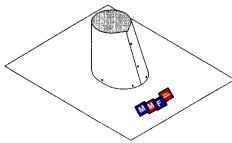

Starter Jack Alum.
Page 5C

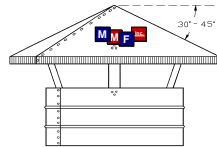

China Cap Galv.
Page 5C

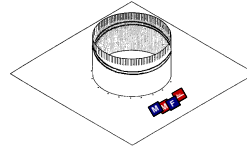

Rotary Vent - Flashing - Conductor Pipe
Page 6C

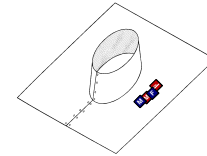

Page 6C

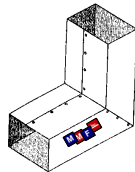

90° Elbow
Page 8C

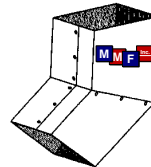

45° Elbow
Page 8C

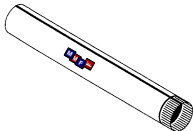

Conductor Pipe
Page 9C

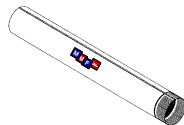

Vent Pipe
Page 9C

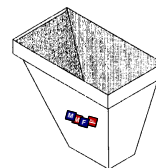

Leader Head Galv.
Page 10C

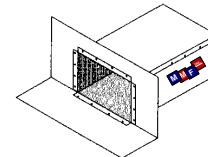

Scuppers
Page 10C

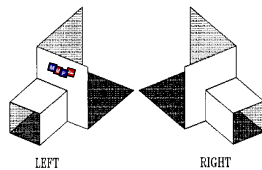

Scupper Left/Right
Page 10C

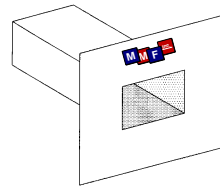

Scupper Splitter/Overflow
Page 10C

7/1/09

PIC25



MODULAR METAL FABRICATORS INC.

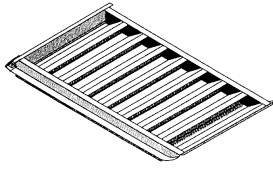

Square Top Louver
Page 12C

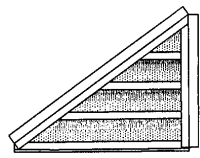

1/4 Tri Louver
Page 13C

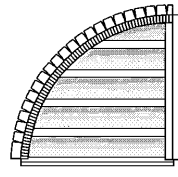

1/4 Radius Louver
Page 13C

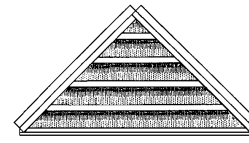

Triangle Louver
Page 14C

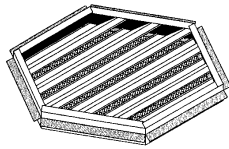

Hexagon Louver
Page 14C

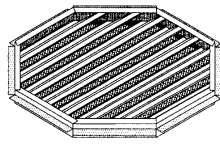

Octagon Louver
Page 14C

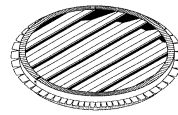

Round Louver
Page 15C

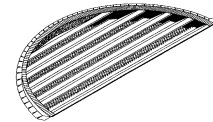

1/2 Round Louver
Page 15C



Clover Leaf
Page 15C

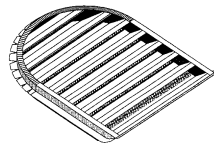

1/2 Round Top
Page 16C

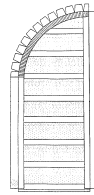

1/2 Radius Top
Page 16C

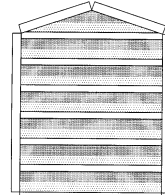

Triangle Top
Page 17C

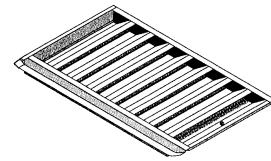

Access Louver
Page 17C

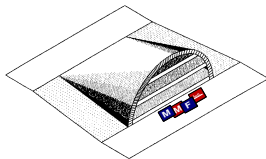

1/2 Round Dormer -w/Aluminum 3 Sides
Page 18C

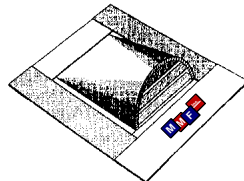

Combustion Vent - w/Aluminum 3 Sides
Page 18C

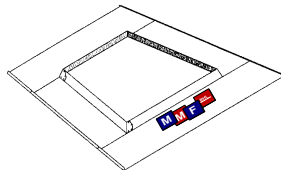
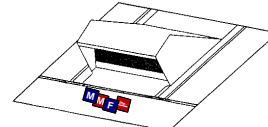
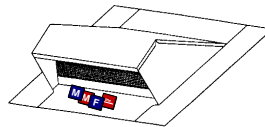

Flashing for 1/2 round Dormer
Page 18C

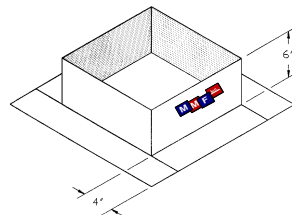

Cooler Flashing / Flat
Page 20C - 20CC

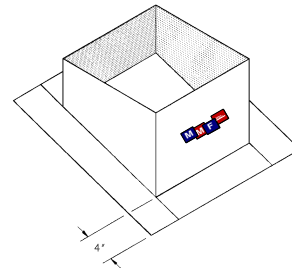

Cooler Flashing / Pitched
Page 20C - 20CC

7/1/09

PIC30



MODULAR METAL FABRICATORS INC.

Master Index

	PRODUCT	PAGE	SECTION
AIR CANS	COMBUSTION-ROUND/RECTANGULAR	28	A
	RETURN AIR CANS	29	A
	SQUARE TO ROUND	28	A
ALUMNIUM FLEX DUCT	FLEXIBLE/COMPRESSED/BARE & RAW	33	A
	FLEXIBLE/FIBERGLASS/VB/CBE	33AA	A
ATTENUATORS	SINGLE/DOUBLE DUCT	6	B
	SINGLE/DOUBLE DUCT	7	B
BOOTS	BOOTS FOR LINEAR AIR BAR	8	B
	PERIMETER BOOTS * PH-1 * PH-2 * PH-3*	12	A
	STRAIGHT - STACKHEAD - CONE BOOTS	11	A
BOXES	C-BOX (RECTANGULAR)	15	A
	CEILING BOX (SQUARE)	14	A
	DUAL REGISTER	10	A
	DUCT BOARD TOP INLET	15	A
	EARS/DAMPERS/SPLITTER INSTALLED	22	A
	FLOOR - REGISTER - SOFFIT	10	A
	SIDE-FEED/OUTLET CEILING BOX	15	A
CAPS	CHINA CAPS	5	C
	PERIMETER CAPS	8	A
	PLENUM CAPS	25	A
	RISER END CAPS	8	A
	ROUND END CAPS	22	A
COLLAR/CONNECTOR	DUCT BOARD START COLLARS - 1"	38	A
	SUPERSEAL START COLLARS	38AA/1BB	A/B
	DUCT CONNECTORS	36	A
	START COLLARS	37	A
	UNIVERSAL CONNECTORS	36	A
COMBUSTION VENT	STANDARD - #100 & #200	18	C
	DSA THREE SIDES - #100 & #200	18	C
CURBS	AIR CONDITIONING	CALL	For Price
	FAN	CALL	For Price
CUSHION-HEADS	1/2" OR 1" LINER - PERFORATED BAFFLE	5	B
	COMMERCIAL SIDE OUTLET FEED	5	B
DAMPERS	DAMPER DISC (NO HARDWARE)	40	A
	DAMPER DISC (WITH HARDWARE)	40	A
	DAMPERS IN BOOTS/BOXES	22	A
	ROUND DAMPERS INSTALLED	22	A
DOWNSPOUT ELBOWS	90°	8	C
	45°	8	C
DRAIN PANS	SOLDERED - 3/4" PVC FITTING - FEMALE	30	A
DUCT BOARD SPIN-INS	ONE SERIES	2	B
	TWO SERIES	2	B
	SPECIFICATIONS	2	B specs

7/1/09

Index



MODULAR METAL FABRICATORS INC.

DUCT-STRAP/HANGER	COMPRESSION CLAMPS	CALL	For Price
	DUCT CLAMP (ID-10") (ID-14")	34	A
	HANGER STRAP	35	A
	PLUMBERS TAPE	35	A
ELBOWS	45° 1 1/2 TIMES RADIUS	14	B
	45° 1" CIRCLE LINED	4	A
	45° ADJUSTABLE	2	A
	90° 1 1/2 TIMES RADIUS	14	B
	90° 1" CIRCLE LINED	3	A
	90° ADJUSTABLE	1	A
	RISER ELBOWS - 90°/45° - STANDARD/FLAT	9	A
	ROOF ELBOWS	CALL	For Price
FILTER BASES	1" FILTER, 1" & 2" FILTERS, 1", 2", & 4" FILTERS	29AA	A
FLASHING	DORMER/COMBUSTION VENT FLASHING	18	C
	CONDUCTOR FLASHINGS	6	C
	COOLER FLASHINGS	20	C
	ROTARY VENT FLASHINGS	6	C
FLEXIBLE AIR DUCT	25' POLY CORE/POLY/SILVER JACKET/RAW	31	A
	6' POLY CORE / POLY/SILVER JACKET	31AA	A
GALV. METAL SHEETS	GALVANIZED METAL SHEETS	41	A
HARDWARE CLOTH	1/4" MESH/SCREEN	41	A
	1/8" MESH/SCREEN	41	A
LEADER HEADS	LEADER HEADS	10	C
LINE SET COVERS	ONE PIECE	30	A
	TWO PIECE	30	A
LINEAR PRODUCTS <i>COMMERCIAL</i>	GOVERNMENT LOCK	27	A
	STANDING S	27	A
LINEAR PRODUCTS <i>RESIDENTIAL</i>	DRIVE	26	A
	PLASTER GROUND AND FRAMES	26	A
	S' LOCK	26	A
LOUVERS	1/2 ROUND	15	C
	1/2 ROUND RADIUS TOP	16	C
	1/2 ROUND TOP	16	C
	1/4 RADIUS	13	C
	1/4 TRI	13	C
	ACCESS	17	C
	CLOVER LEAF	15	C
	HEXAGON	14	C
	OCTAGON	14	C
	ROUND	15	C
	SQUARE TOP	12	C
	TRIANGLE TOP	17	C
	TRIANGLE	14	C

7/1/09

Index



MODULAR METAL FABRICATORS INC.

PERFORATED DIFFUSER	FILTER GRILL	4	B
	GRILL/FACE ONLY	4	B
	METAL SIDES/FIBERGLASS BACK	4	B
	METAL SIDES/METAL BACK	4	B
	MOLDED FIBERGLASS BACK	4	B
	RETURN-MOLDED FIBERGLASS BACK	4	B
	SUPPLY-MOLDED FIBERGLASS BACK	4	B
	UNIVERSAL	4	B
PERIMETER EXT./ADAPT.	PERIMETER EXTENSIONS	13	A
	PERIMETER ADAPTERS	13	A
PIPE	1" CIRCLE LINED ASSEMBLED PIPE	7	A
	CONDUCTOR	9	C
	RISER PIPE	8	A
	SNAPLOCK - ASSEMBLED -W/ FIBERGLASS	6	A
	SNAPLOCK/BUTTONLOCK KD	5	A
	SPIRAL PIPE	13	B
	VENT PIPE/CONDUCTOR	9	C
PLENUMS	COLLARS INSTALLED IN PLENUMS	25	A
	FILTER RACK/TURNING VANE INSTALLED	25	A
	ROUND PLENUMS	28	A
	SQUARE/RECTANGULAR/TRANSITION	25	A
REDUCER/INCREASER	3-PIECE REDUCERS/INCREASERS	24	A
	PANCAKE TAPER - "COOKIE CUTTER"	5	B
SADDLE TAPS	90° ON SADDLE OR FLAT	21	A
	45° ON SADDLE OR FLAT	21	A
	RECTANGULAR SADDLE TAP	15	B
SCUPPER	RIGHT	10	C
	LEFT	10	C
SCUPPER/SPLITTER	OVERFLOW	10	C
SHEET METAL SPIN-IN	ONE SERIES	1	B
	TWO SERIES (CONICAL)	1	B
	SPECIFICATIONS	1	B
SLEEVES	ROUND SLEEVES W/OR W/OUT DAMPERS	17	B
	SQUARE/RECTANGULAR/TRANSITIONIAL	25	A
STARTER JACKS	FOR DEAD SOFT ALUMINUM TEE TOPS	5	C
TAPERS (BELL TYPE)	TAPERS - 18" AND 24 " HIGH	24	A
	TAPERS - 8" AND 12" HIGH	23	A
TEE-TOP VENTS	CHINA CAP	5	C
	DEAD SOFT ALUMINUM	5	C
	STANDARD/SHAKE/GALV/BONDERIZED	4	C
TRANSITIONS	ROUND NECK ADAPTERS	3	B
	SQUARE TO ROUND	28	A
	SQUARE TO SQUARE	3	B
	TRANSITIONAL SLEEVES/DAMPERS	25	A

7/1/09

Index



MODULAR METAL FABRICATORS INC.

VENT PRODUCTS	BLISS DRYER VENT	2	C
	DRYER VENTS	2	C
	EYEBROWS/WALL CAPS/REFRIGERATION	1	C
	FOUNDATIOIN VENTS/STAMPED/STUCCO	3	C
	SPROUL DRYER VENTS	2	C
WYE BRANCHES	WYE BRANCH	21	A
WYES/TEES	1" CIRCLE LINED WYES	18	A
	DAMPER INSTALLED IN WYES	22	A
	NON-STOCK WYES	17	A
	PANTS WYE/SPLITTER WYE (45°/45°)	20	A
	PANTS /SPLITTER WYE (90°/90°) (90°/45°)	19	A
	REVERSE WYE	17	A
	STOCK WYES	16	A
	TEES	17	A

7/1/09

Index



MODULAR METAL FABRICATORS INC.

90° Elbows - Adjustable

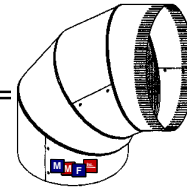

90 Degree Elbows-Adjustable

SIZE	LIST PRICE 30 GA	PART NUMBER	LIST PRICE 28 GA	PART NUMBER	LIST PRICE 26 GA	PART NUMBER	LIST PRICE 24 GA	PART NUMBER	LIST PRICE 22 GA	PART NUMBER
3"	\$1.27	ELGA03			\$1.66	ELIA03				
4"	\$1.52	ELGA04			\$1.77	ELIA04	\$2.80	ELJA04	Jun-04	N/A
5"	\$1.91	ELGA05			\$2.40	ELIA05	\$3.32	ELJA05	Jun-04	N/A
6"	\$2.05	ELGA06			\$2.77	ELIA06	\$3.79	ELJA06	\$8.57	ELKA06
7"	\$2.34	ELGA07			\$3.26	ELIA07	\$4.43	ELJA07	\$9.33	ELKA07
8"	\$2.66	ELGA08			\$3.71	ELIA08	\$4.77	ELJA08	\$10.07	ELKA08
9"	\$3.44	ELGA09			\$4.34	ELIA09	\$5.37	ELJA09	\$11.33	ELKA09
10"	\$3.79	ELGA10			\$4.82	ELIA10	\$6.05	ELJA10	\$12.70	ELKA10
12"			\$6.62	ELHA12	\$7.75	ELIA12	\$8.73	ELJA12	\$18.37	ELKA12
14"			\$8.01	ELHA14	\$9.90	ELIA14	\$11.11	ELJA14	\$23.83	ELKA14
16"			\$10.68	ELHA16	\$13.26	ELIA16	\$15.33	ELJA16	\$32.37	ELKA16
18"			\$13.98	ELHA18	\$14.71	ELIA18	\$19.12	ELJA18	\$40.33	ELKA18
20"					\$16.74	ELIA20	\$23.26	ELJA20	\$49.00	ELKA20
22"							\$31.37	ELJA22	\$69.20	ELKA22
24"							\$45.06	ELJA24	\$73.56	ELKA24
26"							\$57.44	ELJA26	\$76.88	ELKA26
28"									\$93.82	ELKA28
30"									\$143.53	ELKA30
32"									\$252.53	ELKA32

3" 30/28/26 GA : 100/CARTON

4" 30/28/26GA : 60/CARTON

	STRAIGHT PACK	BUNDLE
5" ALL GA:	72	12
6" ALL GA:	50	12
7" ALL GA:	32	12
8" ALL GA:	32	12
9" & 10" 30,28,26, GA:	18	12
9" & 10" ALL OTHER GA:		12
12" ALL GA:	8	8
14" ALL GA:	8	4
16" THRU 26" ALL GA: LOOSE		

FOUR GORE ASSEMBLY: 3" - 20"
FIVE GORE ASSEMBLY: 22" & ABOVE
STANDARD WITH CRIMP ONE END,
RAW OTHER.

CRIMP BOTH ENDS
UNDERSIZE / BEAD BOTH ENDS
CALL FOR QUOTE

**** NOTICE ****
 Catalog pricing is based on a "standard pack" quantity.
 Non "standard pack" quantity orders may be subject to an
 additional charge.

Multi: _____

7/1/09

r6/4/09

1A-01



MODULAR METAL FABRICATORS INC.

45° Elbows - Adjustable

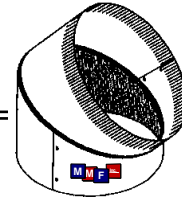

45 Degree Elbows-Adjustable

SIZE	LIST PRICE 30 GA	PART NUMBER	LIST PRICE LIST	PART NUMBER	LIST PRICE 26 GA	PART NUMBER	LIST PRICE 24 GA	PART NUMBER	LIST PRICE 22 GA	PART NUMBER
4"	\$5.53	ELGB04			\$1.87	ELIB04	\$2.53	ELJB04	Jun-04	N/A
5"	\$1.87	ELGB05			\$2.00	ELIB05	\$2.73	ELJB05	Jun-04	N/A
6"	\$2.00	ELGB06			\$2.20	ELIB06	\$2.87	ELJB06	\$4.30	ELKB06
7"	\$2.82	ELGB07			\$3.20	ELIB07	\$4.23	ELJB07	\$6.37	ELKB07
8"	\$3.10	ELGB08			\$3.47	ELIB08	\$4.43	ELJB08	\$6.67	ELKB08
9"	\$3.83	ELGB09			\$4.13	ELIB09	\$5.13	ELJB09	\$7.70	ELKB09
10"	\$4.20	ELGB10			\$4.43	ELIB10	\$5.40	ELJB10	\$8.07	ELKB10
12"			\$5.53	ELHB12	\$5.87	ELIB12	\$6.80	ELJB12	\$10.20	ELKB12
14"			\$6.80	ELHB14	\$7.63	ELIB14	\$8.73	ELJB14	\$13.07	ELKB14
16"			\$9.60	ELHB16	\$11.86	ELIB16	\$12.73	ELJB16	\$22.73	ELKB16
18"			\$12.87	ELHB18	\$12.36	ELIB18	\$17.23	ELJB18	\$25.87	ELKB18
20"					\$14.12	ELIB20	\$20.20	ELJB20	\$35.63	ELKB20
22"							\$28.91	ELJB22	\$39.92	ELKB22
24"							\$32.95	ELJB24	\$43.56	ELKB24
26"							\$42.73	ELJB26	\$45.82	ELKB26
28"									\$84.44	ELKB28
30"									\$129.18	ELKB30

**45° ELBOWS -
STANDARD PACKAGING: LOOSE**

**TWO GORE ASSEMBLY: 3" - 20"
THREE GORE ASSEMBLY: 22" & ABOVE
STANDARD WITH CRIMP ONE END,
RAW OTHER.**

**CRIMP BOTH ENDS
UNDERSIZE / BEAD BOTH ENDS
Call for Quote**

**** NOTICE ****
Catalog pricing is based on a "standard pack" quantity.
Non "standard pack" quantity orders may be subject to an
additional charge.

Multi: _____

7/1/09

r6/4/09

2A-01



1" Circle Lined 90° Elbows

Glued/Buttered Both Ends

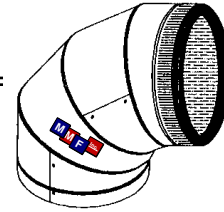

OD	ID	LIST PRICE	PART NUMBER	LIST PRICE	PART NUMBER
		26 GA		24 GA	
8	6	\$24.20	ELCLAI08	\$29.90	ELCLAJ08
9	7	\$27.93	ELCLAI09	\$36.40	ELCLAJ09
10	8	\$28.53	ELCLAI10	\$38.47	ELCLAJ10
12	10	\$33.17	ELCLAI12	\$43.73	ELCLAJ12
14	12	\$46.13	ELCLAI14	\$60.67	ELCLAJ14
16	14	\$55.00	ELCLAI16	\$72.07	ELCLAJ16
18	16	\$71.83	ELCLAI18	\$83.33	ELCLAJ18
20	18	\$91.90	ELCLAI20	\$107.20	ELCLAJ20

OD = OUTSIDE DIMENSION

ID = INSIDE DIMENSION

**** NOTICE ****

Catalog pricing is based on a "standard pack" quantity.
 Non "standard pack" quantity orders may be subject to an additional charge.

Multi: _____

7/1/09

r5/1/10

3A-01



1" Circle Lined 45° Elbows

Glued/Buttered Both Ends

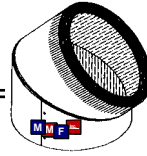

OD	ID	LIST	PART	LIST	PART
		PRICE		NUMBER	
		26 GA			24 GA
8	6	\$16.80	ELCLBI08	\$22.90	ELCLBJ08
9	7	\$19.37	ELCLBI09	\$23.53	ELCLBJ09
10	8	\$19.73	ELCLBI10	\$24.93	ELCLBJ10
12	10	\$23.01	ELCLBI12	\$29.40	ELCLBJ12
14	12	\$32.01	ELCLBI14	\$40.87	ELCLBJ14
16	14	\$38.13	ELCLBI16	\$48.73	ELCLBJ16
18	16	\$48.13	ELCLBI18	\$55.37	ELCLBJ18
20	18	\$61.67	ELCLBI20	\$70.97	ELCLBJ20

**OD= OUTSIDE
DIMENSION**

**ID= INSIDE
DIMENSION**

**** NOTICE ****

Catalog pricing is based on a "standard pack" quantity.
Non "standard pack" quantity orders, may be subject
to an additional charge.

Multi: _____

7/1/09

r5/1/10

4A-01



MODULAR METAL FABRICATORS INC.

Button-Lock Pipe KD - 36" Lengths Bare - Raw One End, Bead and Crimp Other - KD

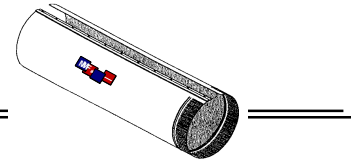

Trade Name = "Snaplock Pipe"

SIZE	LIST PRICE	PART NUMBER	LIST PRICE	PART NUMBER	LIST PRICE	PART NUMBER	LIST PRICE	PART NUMBER
	30 GA		28 GA		26 GA		24 GA	
3"	\$4.63	SLKG3603						
4"	\$4.63	SLKG3604			\$4.83	SLKI3604	\$7.73	SLKJ3604
5"	\$5.00	SLKG3605			\$5.57	SLKI3605	\$8.33	SLKJ3605
6"	\$6.00	SLKG3606			\$6.57	SLKI3606	\$8.90	SLKJ3606
7"	\$6.90	SLKG3607			\$7.43	SLKI3607	\$10.23	SLKJ3607
8"	\$7.23	SLKG3608			\$8.40	SLKI3608	\$11.13	SLKJ3608
9"	\$8.53	SLKG3609			\$9.47	SLKI3609	\$12.70	SLKJ3609
10"	\$9.23	SLKG3610			\$10.20	SLKI3610	\$13.93	SLKJ3610
12"	\$11.03	SLKG3612	\$12.13	SLKH3612	\$12.73	SLKI3612	\$16.27	SLKJ3612
14"			\$13.73	SLKH3614	\$17.13	SLKI3614	\$21.63	SLKJ3614
16"			\$16.70	SLKH3616	\$18.97	SLKI3616	\$24.43	SLKJ3616
18"			\$21.83	SLKH3618	\$22.83	SLKI3618	\$29.00	SLKJ3618
20"					\$26.50	SLKI3620	\$32.40	SLKJ3620
22"							\$45.77	SLKJ3622
24"							\$60.10	SLKJ3624
26"							\$70.93	SLKJ3626

30GA
10 per Bundle

28GA
10 per Bundle

26GA
4"-12"
10 per Bundle

14"-18"
5 per Bundle

24GA
5 per Bundle

Button-Lock Pipe KD - 60" Lengths Bare - Raw One End, Bead and Crimp Other - KD

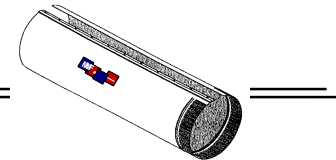

Trade Name = "Snaplock Pipe"

SIZE	LIST PRICE	PART NUMBER	LIST PRICE	PART NUMBER	LIST PRICE	PART NUMBER	LIST PRICE	PART NUMBER
	30 GA		28 GA		26 GA		24 GA	
4"	\$7.70	SLKG6004			\$8.07	SLKI6004	\$12.90	SLKJ6004
5"	\$8.33	SLKG6005			\$9.27	SLKI6005	\$13.93	SLKJ6005
6"	\$10.03	SLKG6006			\$10.93	SLKI6006	\$14.83	SLKJ6006
7"	\$11.50	SLKG6007			\$12.53	SLKI6007	\$17.07	SLKJ6007
8"	\$12.07	SLKG6008			\$14.00	SLKI6008	\$18.57	SLKJ6008
9"	\$14.20	SLKG6009			\$15.77	SLKI6009	\$21.13	SLKJ6009
10"	\$15.40	SLKG6010			\$17.00	SLKI6010	\$23.20	SLKJ6010
12"			\$20.23	SLKH6012	\$21.27	SLKI6012	\$27.10	SLKJ6012
14"			\$23.10	SLKH6014	\$28.57	SLKI6014	\$36.10	SLKJ6014

30GA
10 per Bundle

28GA
26GA
24GA
5 per Bundle

14" IS THE LARGEST MANUFACTURED DIAMETER IN 60" LENGTHS

**** NOTICE ****
Catalog pricing is based on a "standard pack" quantity.
Non "standard pack" quantity orders may be subject to an additional charge.

Multi: _____

7/1/09

r7/1/06

5A-05



MODULAR METAL FABRICATORS INC.

Button-Lock Pipe - 72" Lengths/Assembled Bare - Raw One End, Bead and Crimp Other -

Trade Name = "Snaplock Pipe"

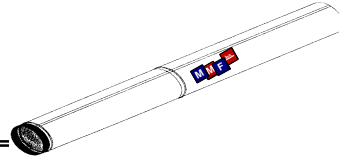

ALSO AVAILABLE WITH CIRCLE LINER, PLEASE CALL FOR PRICING.

SIZE	LIST PRICE	PART	LIST PRICE	PART	LIST PRICE	PART	LIST PRICE	PART
	30 GA	NUMBER	28 GA	NUMBER	26 GA	NUMBER	24 GA	NUMBER
4"	\$11.37	SLAG7204	\$12.13	SLAH7204	\$13.03	SLAI7204	\$17.50	SLAJ7204
5"	\$12.80	SLAG7205	\$13.93	SLAH7205	\$15.03	SLAI7205	\$18.37	SLAJ7205
6"	\$14.90	SLAG7206	\$16.47	SLAH7206	\$17.83	SLAI7206	\$20.13	SLAJ7206
7"	\$17.50	SLAG7207	\$18.60	SLAH7207	\$20.70	SLAI7207	\$23.37	SLAJ7207
8"	\$19.07	SLAG7208	\$21.03	SLAH7208	\$22.50	SLAI7208	\$25.13	SLAJ7208
9"	\$22.50	SLAG7209	\$23.73	SLAH7209	\$26.70	SLAI7209	\$30.17	SLAJ7209
10"	\$26.27	SLAG7210	\$28.50	SLAH7210	\$29.83	SLAI7210	\$33.97	SLAJ7210
12"	\$30.40	SLAG7212	\$32.73	SLAH7212	\$34.07	SLAI7212	\$38.63	SLAJ7212
14"			\$37.20	SLAH7214	\$41.10	SLAI7214	\$51.23	SLAJ7214
16"			\$41.53	SLAH7216	\$46.67	SLAI7216	\$58.57	SLAJ7216
18"			\$48.77	SLAH7218	\$52.10	SLAI7218	\$63.23	SLAJ7218
20"					\$58.13	SLAI7220	\$77.50	SLAJ7220
22"							\$92.40	SLAJ7222
24"							\$133.17	SLAJ7224
26"							\$162.57	SLAJ7226

Button-Lock Pipe - 72" Lengths/Assembled 1 1/2" Fiberglass & Vapor Barrier Raw One End, Bead & Crimp Other

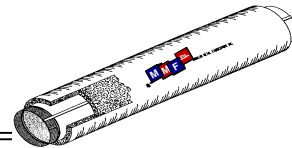

SIZE	LIST PRICE	PART	LIST PRICE	PART	LIST PRICE	PART	LIST PRICE	PART
	30 GA	NUMBER	28 GA	NUMBER	26 GA	NUMBER	24 GA	NUMBER
4"	\$20.50	SLIG7204	\$21.93	SLIH7204	\$23.37	SLII7204	\$26.60	SLIJ7204
5"	\$21.93	SLIG7205	\$23.37	SLIH7205	\$25.43	SLII7205	\$27.83	SLIJ7205
6"	\$26.60	SLIG7206	\$27.50	SLIH7206	\$29.50	SLII7206	\$31.83	SLIJ7206
7"	\$29.83	SLIG7207	\$31.27	SLIH7207	\$33.17	SLII7207	\$35.77	SLIJ7207
8"	\$32.73	SLIG7208	\$35.40	SLIH7208	\$37.20	SLII7208	\$38.97	SLIJ7208
9"	\$36.83	SLIG7209	\$39.77	SLIH7209	\$40.43	SLII7209	\$44.53	SLIJ7209
10"	\$42.10	SLIG7210	\$44.53	SLIH7210	\$45.33	SLII7210	\$49.43	SLIJ7210
12"	\$47.43	SLIG7212	\$50.10	SLIH7212	\$51.57	SLII7212	\$55.67	SLIJ7212
14"			\$63.80	SLIH7214	\$69.17	SLII7214	\$74.37	SLIJ7214
16"			\$76.70	SLIH7216	\$83.63	SLII7216	\$90.20	SLIJ7216
18"			\$82.83	SLIH7218	\$87.50	SLII7218	\$98.43	SLIJ7218
20"					\$97.77	SLII7220	\$114.70	SLIJ7220
22"							\$139.73	SLIJ7222
24"							\$166.70	SLIJ7224
26"							\$184.83	SLIJ7226

** NOTICE ** Catalog pricing is based on "standard pack" quantity. Non "standard pack" quantity orders may be subject to an additional charge.

Multi: _____

7/1/09

6A-05



MODULAR METAL FABRICATORS INC.

1" Circle-Lined Pipe Glued/Buttered Both Ends 3' Lengths - Raw One End - Bead & Crimp Other

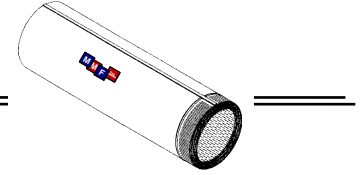

OD	ID	LIST	PART	LIST	PART
		PRICE		PRICE	
		26 GA	NUMBER	24 GA	NUMBER
8"	6"	\$38.80	SLCI0836	\$42.97	SLCJ0836
9"	7"	\$41.93	SLCI0936	\$45.04	SLCJ0936
10"	8"	\$44.33	SLCI1036	\$45.74	SLCJ1036
12"	10"	\$49.23	SLCI1236	\$54.90	SLCJ1236
14"	12"	\$58.97	SLCI1436	\$65.27	SLCJ1436
16"	14"	\$61.50	SLCI1636	\$75.20	SLCJ1636
18"	16"	\$95.27	SLCI1836	\$97.70	SLCJ1836
20"	18"	\$111.70	SLCI2036	\$122.13	SLCJ2036

* * NOTICE * *

Catalog pricing is based on a "standard pack" quantity.
Non "standard pack" quantity orders, may be subject
to an additional charge.

Multi: _____

7/1/09

r5/1/10

7A-05



MODULAR METAL FABRICATORS INC.

Riser Pipe 30 Gauge - KD

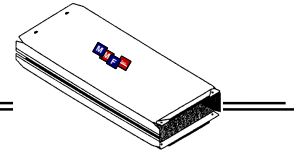

SIZE	LIST PRICE	PART NUMBER	LIST PRICE	PART NUMBER	LIST PRICE	PART NUMBER	LIST PRICE	PART NUMBER
	8" X 3 1/4"		10" X 3 1/4"		12" X 3 1/4"		14" X 3 1/4"	
3'L	\$9.73	RIPG0803K	\$10.47	RIPG1003K	\$10.90	RIPG1203K	\$11.60	RIPG1403K
4'L	\$13.90	RIPG0804K	\$14.93	RIPG1004K	\$15.53	RIPG1204K	\$16.57	RIPG1404K
5'L	\$17.40	RIPG0805K	\$18.67	RIPG1005K	\$19.40	RIPG1205K	\$20.67	RIPG1405K
6'L	\$20.87	RIPG0806K	\$22.37	RIPG1006K	\$23.30	RIPG1206K	\$24.80	RIPG1406K
8'L	\$26.00	RIPG0808K	\$27.87	RIPG1008K	\$29.03	RIPG1208K	\$30.93	RIPG1408K
9'L	\$29.23	RIPG0809K	\$31.37	RIPG1009K	\$32.67	RIPG1209K	\$34.80	RIPG1409K
10'L	\$34.77	RIPG0810K	\$37.27	RIPG1010K	\$38.83	RIPG1210K	\$41.37	RIPG1410K

Riser Pipe 30 Gauge - Assembled

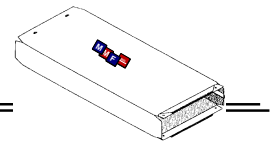

SIZE	LIST PRICE	PART NUMBER	LIST PRICE	PART NUMBER	LIST PRICE	PART NUMBER	LIST PRICE	PART NUMBER
	8" X 3 1/4"		10" X 3 1/4"		12" X 3 1/4"		14" X 3 1/4"	
3'L	\$10.73	RIPG0803A	\$11.30	RIPG1003A	\$12.03	RIPG1203A	\$12.63	RIPG1403A
4'L	\$15.30	RIPG0804A	\$16.17	RIPG1004A	\$17.17	RIPG1204A	\$18.03	RIPG1404A
5'L	\$19.13	RIPG0805A	\$20.20	RIPG1005A	\$21.47	RIPG1205A	\$22.53	RIPG1405A
6'L	\$23.00	RIPG0806A	\$24.30	RIPG1006A	\$25.70	RIPG1206A	\$27.00	RIPG1406A
8'L	\$27.17	RIPG0808A	\$30.20	RIPG1008A	\$32.10	RIPG1208A	\$33.70	RIPG1408A
9'L	\$32.17	RIPG0809A	\$33.97	RIPG1009A	\$36.10	RIPG1209A	\$37.90	RIPG1409A
10'L	\$38.30	RIPG0810A	\$40.50	RIPG1010A	\$42.83	RIPG1210A	\$45.03	RIPG1410A

Riser / Perimeter End Caps - 30 Gauge

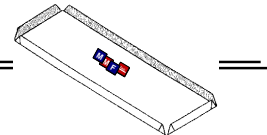

SIZE	LIST PRICE	PART NUMBER	SIZE	LIST PRICE	PART NUMBER
3 1/4 x 8	\$2.23	RICG0308	6 x 8	\$2.40	RICG0608
3 1/4 x 10	\$2.33	RICG0310	6 x 10	\$2.50	RICG0610
3 1/4 x 12	\$2.57	RICG0312	6 x 12	\$2.70	RICG0612
3 1/4 x 14	\$2.73	RICG0314	6 x 14	\$2.93	RICG0614
4 x 8	\$2.23	RICG0408	6 x 16	\$4.00	RICG0616
4 x 10	\$2.33	RICG0410	6 x 18	\$4.63	RICG0618
4 x 12	\$2.57	RICG0412	6 x 20	\$5.43	RICG0620
4 x 14	\$2.73	RICG0414			
4 x 16	\$3.73	RICG0416			
4 x 18	\$4.40	RICG0418			
4 x 20	\$6.90	RICG0420			

RISER PIPE IS STANDARD WITH S'LOCK ONE END, DIMPLE OTHER.

**** NOTICE **** Catalog pricing is based on "standard pack" quantity. Non "standard pack" quantity orders may be subject to an additional charge.

Multi: _____

7/1/09

8A-03



MODULAR METAL FABRICATORS INC.

Riser Elbows - 90° Standard (SHORT WAY)

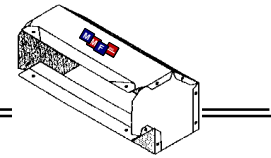

SIZE	GAUGE	LIST PRICE	PART NUMBER
8"	30	\$3.60	RIEG08AS
10"	30	\$4.17	RIEG10AS
12"	30	\$4.77	RIEG12AS
14"	30	\$5.23	RIEG14AS

Riser Elbows - 45° Standard (SHORT WAY)

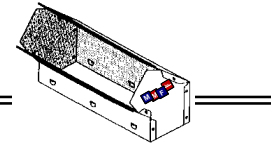

SIZE	GAUGE	LIST PRICE	PART NUMBER
8"	30	\$3.57	RIEG08BS
10"	30	\$3.77	RIEG10BS
12"	30	\$4.13	RIEG12BS
14"	30	\$4.77	RIEG14BS

Riser Elbows - 90° Flat (LONG WAY)

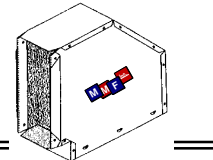

SIZE	GAUGE	LIST PRICE	PART NUMBER
8"	30	\$5.43	RIEG08AF
10"	30	\$5.57	RIEG10AF
12"	30	\$6.13	RIEG12AF
14"	30	\$7.23	RIEG14AF

Riser Elbows - 45° Flat (LONG WAY)

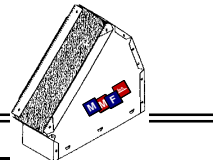

SIZE	GAUGE	LIST PRICE	PART NUMBER
8"	30	\$4.80	RIEG08BF
10"	30	\$5.20	RIEG10BF
12"	30	\$5.57	RIEG12BF
14"	30	\$6.13	RIEG14BF

ALL RISER ELBOWS STANDARD WITH S'LOCK ONE END, DIMPLES OTHER.

**** NOTICE **** Catalog pricing is based on "standard pack" quantity.
Non "standard pack" quantity orders may be subject to an additional charge.

Multi: _____

7/1/09

9A-03



MODULAR METAL FABRICATORS INC.

Floor Box - 30 Gauge

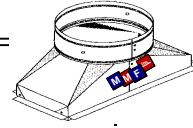

SIZE	LIST PRICE STOCK W/PG	PART NUMBER
8 x 4 x 4	\$4.77	BTFG080404P
8 x 4 x 5	\$4.77	BTFG080405P
# x 4 x 5	\$5.33	BTFG100405P
# x 4 x 6	\$5.37	BTFG100406P
# x 6 x 6	\$5.43	BTFG100606P
# x 6 x 7	\$5.80	BTFG100607P
# x 6 x 6	\$5.93	BTFG120606P
# x 6 x 7	\$5.93	BTFG120607P
# x 6 x 8	\$6.37	BTFG120608P
# x 6 x 7	\$7.83	BTFG140607P
# x 6 x 8	\$8.00	BTFG140608P
# x 8 x 8	\$8.43	BTFG140808P
# x 8 x 9	\$8.53	BTFG140809P

SIZE	LIST PRICE NON-STOCK W/PG	PART NUMBER
6"	\$4.57	BTFG06___P
8"	\$5.10	BTFG08___P
10"	\$5.80	BTFG10___P
12"	\$6.37	BTFG12___P
14"	\$9.53	BTFG14___P
16"	\$12.03	BTFG16___P
18"	\$13.43	BTFG18___P
20"	\$15.67	BTFG20___P
22"	\$23.17	BTFG22___P
24"	\$24.43	BTFG24___P
26"	\$26.80	BTFG26___P
28"	\$29.17	BTFG28___P
30"	\$31.53	BTFG30___P

Register Box - 30 Gauge

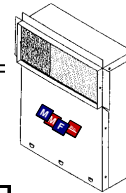

SIZE	LIST PRICE	PART NUMBER
8"	\$4.43	BRBG08___
10"	\$5.53	BRBG10___
12"	\$5.63	BRBG12___
14"	\$6.47	BRBG14___
16"	\$9.30	BRBG16___
18"	\$11.93	BRBG18___
20"	\$14.47	BRBG20___

STOCK SIZES:

SIZE	LIST PRICE STOCK	PART NUMBER
8 x 3 x 4	\$4.43	BRBG080304
10 x 3 x 4	\$5.53	BRBG100304
10 x 3 x 6	\$5.53	BRBG100306
12 x 3 x 6	\$5.63	BRBG120306
14 x 3 x 6	\$6.47	BRBG140306
14 x 3 x 8	\$6.47	BRBG140308

STANDARD WITH PG'S UNLESS OTHERWISE SPECIFIED. PLEASE CALL FOR DUAL BOX PRICING.

Soffit Boxes - 12" High - 30 Gauge

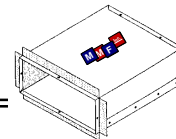

SIZE	LIST PRICE		LIST PRICE	
	NO COLLAR W/PG	PART NUMBER	NO COLLAR NO PG	PART NUMBER
8 x 4	\$6.23	BXFG0804D	\$5.77	BXFG0804A
10 x 4	\$7.40	BXFG1004D	\$6.87	BXFG1004A
10 x 6	\$7.50	BXFG1006D	\$6.97	BXFG1006A
12 x 6	\$7.93	BXFG1206D	\$7.13	BXFG1206A
14 x 4	\$9.00	BXFG1404D	\$7.63	BXFG1404A
14 x 6	\$9.67	BXFG1406D	\$9.07	BXFG1406A
14 x 8	\$9.73	BXFG1408D	\$9.23	BXFG1408A
14 x 9	\$9.90	BXFG1409D	\$9.57	BXFG1409A

FOR SIZES AND GAUGES NOT SHOWN, PLEASE CALL FOR PRICING.

Multi: _____

7/1/09

r5/1/10

10A-03



MODULAR METAL FABRICATORS INC.

Straight Boot - 30 Gauge

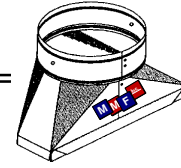

SIZE	LIST PRICE	PART NUMBER
8 x 3 1/4 x 4	\$3.30	BTSG080304
8 x 3 1/4 x 5	\$3.30	BTSG080305
10 x 3 1/4 x 5	\$3.37	BTSG100305
10 x 3 1/4 x 6	\$3.50	BTSG100306
10 x 3 1/4 x 7	\$3.60	BTSG100307
12 x 3 1/4 x 7	\$3.87	BTSG120307
14 x 3 1/4 x 8	\$4.67	BTSG140308
14 x 3 1/4 x 9	\$5.13	BTSG140309

STANDARD WITH
S'LOCK

FOR SIZES AND
GAUGES NOT
SHOWN, PLEASE
CALL FOR
PRICING.

Stackhead Boot - 30 Gauge

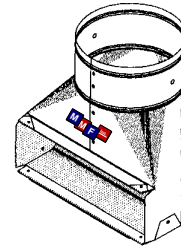

SIZE	LIST PRICE	PART NUMBER
8 x 3 1/4 x 4	\$5.17	BTHG080304
8 x 3 1/4 x 5	\$5.17	BTHG080305
10 x 3 1/4 x 5	\$5.27	BTHG100305
10 x 3 1/4 x 6	\$5.40	BTHG100306
10 x 3 1/4 x 7	\$5.50	BTHG100307
12 x 3 1/4 x 7	\$5.70	BTHG120307
14 x 3 1/4 x 8	\$6.50	BTHG140308
14 x 3 1/4 x 9	\$7.10	BTHG140309

STANDARD WITH
S'LOCK

FOR SIZES AND
GAUGES NOT
SHOWN, PLEASE
CALL FOR
PRICING.

Cone Boot - 30 Gauge

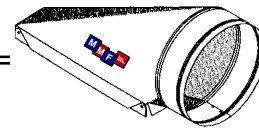

SIZE	LIST PRICE	PART NUMBER
8 x 3 1/4 x 4	\$6.23	BTCG080304
8 x 3 1/4 x 5	\$6.23	BTCG080305
10 x 3 1/4 x 5	\$6.33	BTCG100305
10 x 3 1/4 x 6	\$6.43	BTCG100306
10 x 3 1/4 x 7	\$6.60	BTCG100307
12 x 3 1/4 x 7	\$7.03	BTCG120307
14 x 3 1/4 x 8	\$8.23	BTCG140308
14 x 3 1/4 x 9	\$8.60	BTCG140309

STANDARD WITH
S'LOCK

FOR SIZES AND
GAUGES NOT
SHOWN, PLEASE
CALL FOR
PRICING.

** NOTICE ** Catalog pricing is based on "standard pack" quantity.
Non "standard pack" quantity orders may be subject to an additional charge.

Multi:

7/1/09

11A-03



MODULAR METAL FABRICATORS INC.

Perimeter Straight Boot - 30 Gauge -*PH-1* 6" Straight

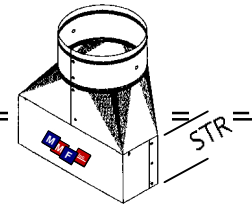

Please specify RAW or with PLASTER GROUND.

PH-1

SIZE UP TO 6" Straight	LIST PRICE	PART NUMBER WITH 6" Straight
8" (3 1/4-6") TO 8" RD	\$5.70	BTXG 08 ___ A
10" (3 1/4-8") TO 8" RD	\$6.37	BTXG 10 ___ A
12" (3 1/4-10") TO 10"RD	\$7.20	BTXG 12 ___ A
14" (3 1/4-1-10") TO 10" RD	\$7.93	BTXG 14 ___ A

Perimeter Stackhead Boot - 30 Gauge -*PH-2* 6" Straight

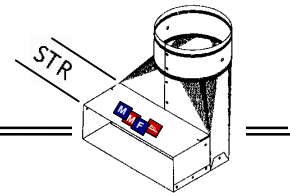

Please specify RAW or with PLASTER GROUND.

PH-2

SIZE UP TO 6" Straight	LIST PRICE	PART NUMBER WITH 6" Straight
8" (3 1/4-6") TO 8" RD	\$7.90	BTZG08 ___ A
10" (3 1/4-8") TO 8" RD	\$8.57	BTZG10 ___ A
12" (3 1/4-10") TO 10"RD	\$9.43	BTZG12 ___ A
14" (3 1/4-1-10") TO 10" RD	\$10.30	BTZG14 ___ A

Perimeter Cone Boot - 30 Gauge -*PH-3* 6" Straight

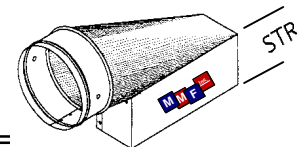

Please specify RAW or with PLASTER GROUND.

PH-3

SIZE UP TO 6" Straight	LIST PRICE	PART NUMBER WITH 6" Straight
8" (3 1/4-6") TO 8" RD	\$8.57	BTYG 08 ___ A
10" (3 1/4-8") TO 8" RD	\$9.10	BTYG 10 ___ A
12" (3 1/4-10") TO 10"RD	\$9.73	BTYG 12 ___ A
14" (3 1/4-1-10") TO 10" RD	\$10.10	BTYG 14 ___ A

PLEASE SPECIFY LENGTH OF STRAIGHT WHEN ORDERING.

ALL PERIMETER BOOTS ARE RAW STANDARD.

FOR SIZES NOT SHOWN, PLEASE CALL FOR PRICING.

**** NOTICE ****
Catalog pricing is based on a "standard pack" quantity.
Non standard pack" quantity orders, may be subject to an additional charge.

Multi: _____

7/1/09

r5/1/10

12A-03



MODULAR METAL FABRICATORS INC.

Perimeter Extension 4" and 6" 30 Gauge Raw

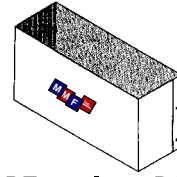

SIZE	LIST PRICE	PART NUMBER 4" HIGH	PART NUMBER 6" HIGH	SIZE	LIST PRICE	PART NUMBER 4" HIGH	PART NUMBER 6" HIGH
2 1/4 x 8	\$1.93	BXEG080204	BXEG080206	3 1/4 x 12	\$2.30	BXEG120304	BXEG120306
3 1/4 x 8	\$1.93	BXEG080304	BXEG080306	4 x 12	\$2.30	BXEG120404	BXEG120406
4 x 8	\$1.93	BXEG080404	BXEG080406	6 x 12	\$2.30	BXEG120604	BXEG120606
2 1/4 x 10	\$2.13	BXEG100204	BXEG100206	2 1/4 x 14	\$2.50	BXEG140204	BXEG140206
3 1/4 x 10	\$2.13	BXEG100304	BXEG100306	3 1/4 x 14	\$2.50	BXEG140304	BXEG140306
4 x 10	\$2.13	BXEG100404	BXEG100406	4 x 14	\$2.50	BXEG140404	BXEG140406
2 1/4 x 12	\$2.23	BXEG120204	BXEG120206	6 x 14	\$2.60	BXEG140604	BXEG140606

Please specify RAW or with PLASTER GROUND.

Perimeter Adapter 6" High 30 Gauge Raw

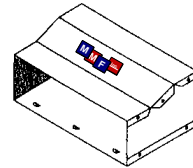

SIZE	LIST PRICE	PART NUMBER	SIZE	LIST PRICE	PART NUMBER
8 x 4 to 8 x 3 1/4	\$6.33	RIAGA	8 x 4 to 8 x 2 1/4	\$6.33	RIAGM
10 x 4 to 10 x 3 1/4	\$6.57	RIAGB	10 x 4 to 12 x 2 1/4	\$6.57	RIAGN
12 x 4 to 12 x 3 1/4	\$6.77	RIAGC	12 x 4 to 12 x 2 1/4	\$6.77	RIAGO
14 x 4 to 14 x 3 1/4	\$7.43	RIAGD	14 x 4 to 14 x 2 1/4	\$7.43	RIAGP

Please specify RAW or with PLASTER GROUND.

ALL EXTENSIONS & ADAPTERS ARE RAW:
ADD 20% FOR PG.
FOR SIZES NOT SHOWN, PLEASE CALL FOR PRICING.

**** NOTICE ****
Catalog pricing is based on a "standard pack" quantity.
Non "standard pack" quantity orders, may be subject
to an additional charge.

Multi: _____

7/1/09

r5/1/10

13A-03



MODULAR METAL FABRICATORS INC.

Square Ceiling Boxes - Top-Feed 30 Gauge with Collar & PG

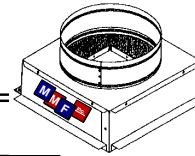

SIZE	LIST PRICE	PART NUMBER	LIST PRICE	PART NUMBER	LIST PRICE	PART NUMBER
	4" HIGH		6" HIGH		8" HIGH	
6"	\$6.60	BXCG0606_A	\$7.60	BXCG0606_D	\$8.90	BXCG0606_G
8"	\$7.63	BXCG0808_A	\$8.70	BXCG0808_D	\$10.27	BXCG0808_G
10"	\$8.50	BXCG1010_A	\$9.67	BXCG1010_D	\$11.63	BXCG1010_G
12"	\$9.80	BXCG1212_A	\$11.17	BXCG1212_D	\$13.63	BXCG1212_G
14"	\$10.97	BXCG1414_A	\$12.47	BXCG1414_D	\$14.97	BXCG1414_G
16"	\$12.07	BXCG1616_A	\$13.70	BXCG1616_D	\$16.50	BXCG1616_G
18"	\$13.30	BXCG1818_A	\$15.20	BXCG1818_D	\$19.23	BXCG1818_G
20"	\$15.63	BXCG2020_A	\$17.80	BXCG2020_D	\$20.93	BXCG2020_G
22"	\$19.17	BXCG2222_A	\$23.07	BXCG2222_D	\$25.77	BXCG2222_G
24"	\$20.90	BXCG2424_A	\$25.13	BXCG2424_D	\$30.63	BXCG2424_G

Square Ceiling Boxes - Top-Feed, 4" High 30 Gauge with Collar & PG - Stock Sizes

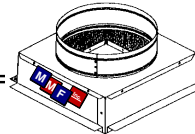

SIZE	PART NUMBER	LIST PRICE
6 x 6 to 5" RD	BXCG060605A	\$6.60
8 x 8 to 7" RD	BXCG080807A	\$7.63
10 x 10 to 8" RD	BXCG101008A	\$8.50
12 x 12 to 10" RD	BXCG121210A	\$9.80
14 x 14 to 12" RD	BXCG141412A	\$10.97

PLEASE STATE RAW, OR FLANGE WHEN ORDERING CEILING BOXES OTHER THAN WITH PG.
FOR COLLARS HIGHER THAN 3" ADD 8%.
FOR OVAL COLLARS ADD 10%.

Square Ceiling Boxes - Top-Feed 30 Gauge - with PG - without Collars - Blank

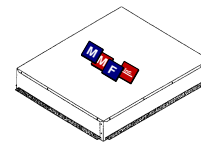

SIZE	LIST PRICE	PART NUMBER	LIST PRICE	PART NUMBER	LIST PRICE	PART NUMBER
	4" HIGH		6" HIGH		8" HIGH	
6"	\$5.60	BXCG0606BA	\$6.40	BXCG0606BD	\$7.53	BXCG0606BG
8"	\$6.80	BXCG0808BA	\$7.33	BXCG0808BD	\$8.70	BXCG0808BG
10"	\$7.70	BXCG1010BA	\$8.57	BXCG1010BD	\$9.93	BXCG1010BG
12"	\$9.07	BXCG1212BA	\$9.97	BXCG1212BD	\$11.73	BXCG1212BG
14"	\$10.10	BXCG1414BA	\$11.00	BXCG1414BD	\$12.97	BXCG1414BG
16"	\$11.27	BXCG1616BA	\$12.27	BXCG1616BD	\$14.40	BXCG1616BG
18"	\$12.93	BXCG1818BA	\$14.40	BXCG1818BD	\$16.57	BXCG1818BG
20"	\$14.90	BXCG2020BA	\$16.20	BXCG2020BD	\$19.07	BXCG2020BG
22"	\$16.43	BXCG2222BA	\$19.60	BXCG2222BD	\$22.30	BXCG2222BG
24"	\$18.57	BXCG2424BA	\$22.33	BXCG2424BD	\$26.50	BXCG2424BG

FOR SIZES AND GAUGES NOT SHOWN, PLEASE CALL FOR PRICING.

Multi: _____

7/1/09

r5/1/10

14A-03



MODULAR METAL FABRICATORS INC.

Side Inlet Ceiling Boxes Side - Feed 30 Gauge with Collars & PG - Per Girth Inch

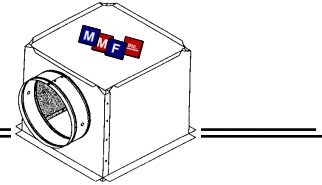

LIST PRICE	
HIGH	PER GIRTH INCH
6"	\$0.33
8"	\$0.33
10"	\$0.37
12"	\$0.40
14"	\$0.43
16"	\$0.43
18"	\$0.43
20"	\$0.47
22"	\$0.47
24"	\$0.50

PLEASE STATE RAW, OR
FLANGE WHEN ORDERING
CEILING BOXES OTHER THAN PG.
FOR COLLARS HIGHER THAN 3" ADD 8%.
FOR OVAL COLLARS ADD 10%.
HEIGHT MUST BE 2" HIGHER
THAN COLLAR SIZE.
FOR SIZES & GAUGES NOT SHOWN,
PLEASE CALL FOR PRICING.

C-Boxes 30 Gauge - 3" Ears Short Side

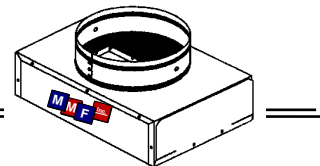

SIZE			LIST PRICE
ROUND			
8 x 4	to	4,5	\$4.13
8 x 6	to	4,5,6	\$4.20
10 x 4	to	4,5,6	\$4.20
10 x 6	to	4,5,6,7	\$4.37
12 x 6	to	4,5,6,7,8	\$4.60
12 x 8	to	4,5,6,7,8,9	\$4.83
14 x 6	to	4,5,6,7,8,9	\$4.83
14 x 8	to	4,5,6,7,8,9	\$5.13

PLEASE SPECIFY: PG-4-SIDES
PG SHORT SIDE
3" EARS SHORT SIDE ONLY
3" EARS SHORT SIDE, PG LONG SIDE
PLEASE CALL FOR PRICING OTHER THAN
3" EARS SHORT SIDE

**** NOTICE ****
Catalog pricing is based on a "standard pack" quantity.
Non "standard pack" quantity orders, may be subject
to an additional charge.

Multi: _____

7/1/09

r5/1/10

15A-03



MODULAR METAL FABRICATORS INC.

Stock 30 & 28 GA Wyes

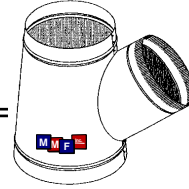

SIZE	LIST PRICE	PART NUMBER	GA	SIZE	LIST PRICE	PART NUMBER	GA
6 x 4 x 4	\$6.27	TYG060404	30	10 x 8 x 8	\$11.10	TYG100808	30
6 x 5 x 5	\$6.27	TYG060505	30	10 x 9 x 6	\$11.10	TYG100906	30
7 x 5 x 5	\$7.00	TYG070505	30	10 x 9 x 7	\$11.10	TYG100907	30
7 x 6 x 5	\$7.00	TYG070605	30	10 x 9 x 8	\$11.10	TYG100908	30
7 x 6 x 6	\$7.00	TYG070606	30	12 x 9 x 8	\$11.97	TYG120908	30
8 x 6 x 5	\$8.40	TYG080605	30	12 x 9 x 9	\$11.97	TYG120909	30
8 x 6 x 6	\$8.40	TYG080606	30	12 x 10 x 6	\$11.97	TYG121006	30
8 x 7 x 5	\$8.40	TYG080705	30	12 x 10 x 7	\$11.97	TYG121007	30
8 x 7 x 6	\$8.40	TYG080706	30	12 x 10 x 8	\$11.97	TYG121008	30
9 x 7 x 6	\$9.60	TYG090706	30	12 x 10 x 9	\$11.97	TYG121009	30
9 x 7 x 7	\$9.60	TYG090707	30	12 x 10 x 10	\$11.97	TYG121010	30
9 x 8 x 5	\$9.60	TYG090805	30	14x 10 x 10	\$13.57	TYH141010	28
9 x 8 x 6	\$9.60	TYG090806	30	14 x 12 x 8	\$13.57	TYH141208	28
9 x 8 x 7	\$9.60	TYG090807	30	14 x 12 x 9	\$13.57	TYH141209	28
10 x 8 x 6	\$11.10	TYG100806	30	14 x 12 x 10	\$13.57	TYH141210	28
10 x 8 x 7	\$11.10	TYG100807	30	14 x 12 x 12	\$13.57	TYH141212	28

**STOCK WYE BRANCHES ARE CRIMP AND BEAD ON THE STEM.
ALSO AVAILABLE WITHOUT CRIMP OR UNDERSIZED WITH NO
ADDITIONAL CHARGE -- NON-STOCK ITEM.**

**FOR DAMPERS INSTALLED IN
WYES, PLEASE SEE PAGE 22A-03.**

**** NOTICE ****
Catalog pricing is based on a "standard pack" quantity.
Non "standard pack" quantity orders may be subject to an additional charge.

Multi: _____

7/1/09

r5/1/10

16A-02



MODULAR METAL FABRICATORS INC.

Non Stock Wyes

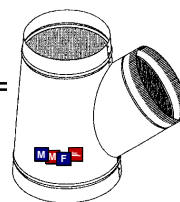

SIZE	LIST PRICE				
	30 GA	28 GA	26 GA	24 GA	22 GA
5"	\$6.27	\$8.23	\$8.60	\$10.03	
6"	\$6.27	\$8.43	\$8.90	\$14.03	
7"	\$7.00	\$9.27	\$10.23	\$14.97	
8"	\$8.40	\$11.10	\$11.80	\$16.30	
9"	\$9.60	\$12.60	\$13.40	\$16.70	
10"	\$11.10	\$12.85	\$15.47	\$16.97	
12"	\$11.97	\$13.08	\$16.73	\$18.03	
14"		\$13.58	\$17.37	\$19.47	
16"		\$19.47	\$23.20	\$25.33	
18"		\$27.10	\$28.40	\$33.37	
20"			\$33.17	\$41.13	
22"			\$46.03	\$49.27	
24"			\$58.67	\$63.30	\$75.83
26"				\$104.13	\$124.73
28"				\$117.07	\$134.67
30"				\$125.30	\$144.10
32"				\$134.07	\$154.20
34"				\$143.43	\$164.97
36"				\$153.50	\$176.53

FOR DAMPERS INSTALLED IN WYES, SEE PAGE 22A

Vent Tees & Wyes - 26 Gauge, Reverse Crimp

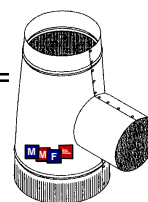

SIZE	LIST PRICE	PART NUMBERS
4"	\$14.14	TYVTI040404
5"	\$15.39	TYVTI050505
6"	\$16.85	TYVTI060606

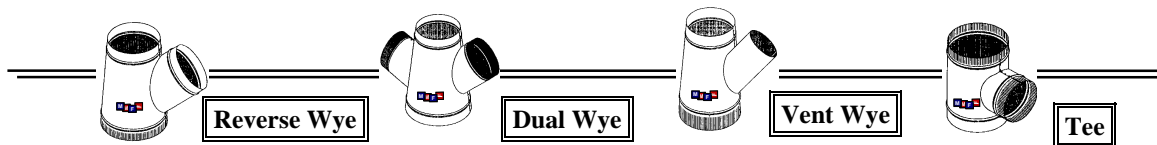

**** NOTICE ****
 Catalog pricing is based on a "standard pack" quantity.
 Non "standard pack" quantity orders, may be subject

**REVERSE & VENT WYE .
 EXTRA BRANCH (DUAL WYE)
 TEE PRICE or CRIMP ALL ENDS
 Call for Quote.**

Multi: _____

7/1/09

r5/1/10

17A-02



MODULAR METAL FABRICATORS INC.

1" Circle Lined Wyes

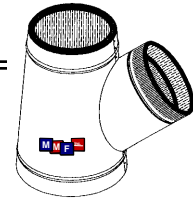

OD	ID	LIST PRICE	PART NUMBER	LIST PRICE	PART NUMBER	LIST PRICE	PART NUMBER
		28 GA		26 GA		24 GA	
8	6	\$63.30	TYCLH08	\$75.20	TYCLI08	\$86.03	TYCLJ08
9	7	\$68.27	TYCLH09	\$80.73	TYCLI09	\$92.80	TYCLJ09
10	8	\$72.20	TYCLH10	\$85.90	TYCLI10	\$97.40	TYCLJ10
12	10	\$75.20	TYCLH12	\$97.00	TYCLI12	\$101.47	TYCLJ12
14	12	\$89.07	TYCLH14	\$105.43	TYCLI14	\$120.17	TYCLJ14
16	14	\$97.00	TYCLH16	\$114.77	TYCLI16	\$131.03	TYCLJ16
18	16			\$153.33	TYCLI18	\$166.73	TYCLJ18
20	18			\$179.83	TYCLI20	\$207.07	TYCLJ20

**** NOTICE ****
 Catalog pricing is based on a "standard pack" quantity.
 Non "standard pack" quantity orders, may be subject to an additional charge.

Multi: _____

7/1/09

R5/1/10

18A-02



MODULAR METAL FABRICATORS INC.

Pants Wye: 90°-90°

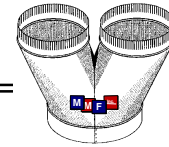

SIZE	LIST PRICE	PART NUMBER	LIST PRICE	PART NUMBER	LIST PRICE	PART NUMBER	LIST PRICE	PART NUMBER	LIST PRICE	PART NUMBER
	30 GA		28 GA		26 GA		24 GA		22 GA	
6"	\$9.91	TYXG06----	\$11.10	TYXH06----	\$11.58	TYXI06----	\$13.55	TYXJ06----	\$20.35	TYXK06----
7"	\$10.16	TYXG07----	\$11.37	TYXH07----	\$11.89	TYXI07----	\$13.90	TYXJ07----	\$20.87	TYXK07----
8"	\$10.50	TYXG08----	\$11.75	TYXH08----	\$12.27	TYXI08----	\$14.35	TYXJ08----	\$21.56	TYXK08----
9"	\$11.93	TYXG09----	\$13.34	TYXH09----	\$13.94	TYXI09----	\$16.33	TYXJ09----	\$24.51	TYXK09----
10"	\$12.82	TYXG10----	\$14.32	TYXH10----	\$14.98	TYXI10----	\$17.54	TYXJ10----	\$26.31	TYXK10----
12"	\$18.17	TYXG12----	\$20.31	TYXH12----	\$21.25	TYXI12----	\$24.86	TYXJ12----	\$37.30	TYXK12----
14"	\$23.26	TYXG14----	\$24.41	TYXH14----	\$27.22	TYXI14----	\$31.86	TYXJ14----	\$47.81	TYXK14----
16"	\$28.98	TYXG16----	\$32.45	TYXH16----	\$33.90	TYXI16----	\$39.70	TYXJ16----	\$59.56	TYXK16----
18"	\$34.63	TYXG18----	\$38.79	TYXH18----	\$40.53	TYXI18----	\$47.46	TYXJ18----	\$71.21	TYXK18----
20"			\$56.34	TYXH20----	\$63.30	TYXI20----	\$76.58	TYXJ20----	\$114.89	TYXK20----
22"					\$92.66	TYXI22----	\$92.66	TYXJ22----	\$139.22	TYXK22----
24"							\$111.42	TYXJ24----	\$166.92	TYXK24----
26"							\$132.94	TYXJ26----	\$199.16	TYXK26----
28"							\$157.46	TYXJ28----	\$235.87	TYXK28----
30"							\$185.71	TYXJ30----	\$277.99	TYXK30----

Pants Wye: 90°-45°

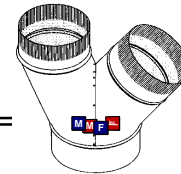

SIZE	LIST PRICE	PART NUMBER	LIST PRICE	PART NUMBER	LIST PRICE	PART NUMBER	LIST PRICE	PART NUMBER	LIST PRICE	PART NUMBER
	30 GA		28 GA		26 GA		24 GA		22 GA	
6"	\$9.91	TYZG06----	\$11.10	TYZH06----	\$11.58	TYZI06----	\$13.55	TYZJ06----	\$20.35	TYZK06----
7"	\$10.16	TYZG07----	\$11.37	TYZH07----	\$11.89	TYZI07----	\$13.90	TYZJ07----	\$20.87	TYZK07----
8"	\$10.50	TYZG08----	\$11.75	TYZH08----	\$12.27	TYZI08----	\$14.35	TYZJ08----	\$21.56	TYZK08----
9"	\$11.93	TYZG09----	\$13.34	TYZH09----	\$13.94	TYZI09----	\$16.33	TYZJ09----	\$24.51	TYZK09----
10"	\$12.82	TYZG10----	\$14.32	TYZH10----	\$14.98	TYZI10----	\$17.54	TYZJ10----	\$26.31	TYZK10----
12"	\$18.17	TYZG12----	\$20.31	TYZH12----	\$21.25	TYZI12----	\$24.86	TYZJ12----	\$37.30	TYZK12----
14"	\$23.26	TYZG14----	\$24.41	TYZH14----	\$27.22	TYZI14----	\$31.86	TYZJ14----	\$47.81	TYZK14----
16"	\$28.98	TYZG16----	\$32.45	TYZH16----	\$33.90	TYZI16----	\$39.70	TYZJ16----	\$59.56	TYZK16----
18"	\$34.63	TYZG18----	\$38.79	TYZH18----	\$40.53	TYZI18----	\$47.46	TYZJ18----	\$71.21	TYZK18----
20"			\$56.34	TYZH20----	\$63.30	TYZI20----	\$76.58	TYZJ20----	\$114.89	TYZK20----
22"					\$92.66	TYZI22----	\$92.66	TYZJ22----	\$139.22	TYZK22----
24"							\$111.42	TYZJ24----	\$166.92	TYZK24----
26"							\$132.94	TYZJ26----	\$199.16	TYZK26----
28"							\$157.47	TYZJ28----	\$235.87	TYZK28----
30"							\$185.71	TYZJ30----	\$277.99	TYZK30----

20" & ABOVE ARE SUBJECT TO A PATTERN CHARGE OF \$35.00 NET.
20" DUAL & ABOVE ARE SUBJECT TO A PATTERN CHARGE OF \$40.00 NET.

**** NOTICE ****
 Catalog pricing is based on a "standard pack" quantity.
 Non "standard pack" quantity orders, may be subject to an additional charge.

Multi: _____

7/1/09

19A-02



MODULAR METAL FABRICATORS INC.

Pants Wye: 45° - 45°

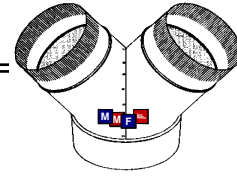

SIZE	LIST PRICE	PART NUMBER	LIST PRICE	PART NUMBER	LIST PRICE	PART NUMBER	LIST PRICE	PART NUMBER	LIST PRICE	PART NUMBER
	30 GA		28 GA		26 GA		24 GA		22 GA	
6"	\$9.91	TYYG06----	\$11.10	TYYH06----	\$11.58	TYII06----	\$13.55	TYYJ06----	\$20.35	TYK06----
7"	\$10.16	TYYG07----	\$11.37	TYYH07----	\$11.89	TYII07----	\$13.90	TYYJ07----	\$20.87	TYK07----
8"	\$10.50	TYYG08----	\$11.75	TYYH08----	\$12.27	TYII08----	\$14.35	TYYJ08----	\$21.56	TYK08----
9"	\$11.93	TYYG09----	\$13.34	TYYH09----	\$13.94	TYII09----	\$16.33	TYYJ09----	\$24.51	TYK09----
10"	\$12.82	TYYG10----	\$14.32	TYYH10----	\$14.98	TYII10----	\$17.54	TYYJ10----	\$26.31	TYK10----
12"	\$18.17	TYYG12----	\$20.31	TYYH12----	\$21.25	TYII12----	\$24.86	TYYJ12----	\$37.30	TYK12----
14"	\$23.26	TYYG14----	\$24.41	TYYH14----	\$27.22	TYII14----	\$31.86	TYYJ14----	\$47.81	TYK14----
16"	\$28.98	TYYG16----	\$32.45	TYYH16----	\$33.90	TYII16----	\$39.70	TYYJ16----	\$59.56	TYK16----
18"	\$34.63	TYYG18----	\$38.79	TYYH18----	\$40.53	TYII18----	\$47.46	TYYJ18----	\$71.21	TYK18----
20"			\$56.34	TYYH20----	\$63.30	TYII20----	\$76.58	TYYJ20----	\$114.89	TYK20----
22"					\$92.66	TYII22----	\$92.66	TYYJ22----	\$139.22	TYK22----
24"							\$111.42	TYYJ24----	\$166.92	TYK24----
26"							\$132.94	TYYJ26----	\$199.16	TYK26----
28"							\$157.46	TYYJ28----	\$235.87	TYK28----
30"							\$185.71	TYYJ30----	\$277.99	TYK30----

20" & ABOVE ARE SUBJECT TO A PATTERN CHARGE OF \$35.00 NET.
20" DUAL & ABOVE ARE SUBJECT TO A PATTERN CHARGE OF \$40.00 NET.

**** NOTICE ****
 Catalog pricing is based on a "standard pack" quantity.
 Non "standard pack" quantity orders may be subject to an additional charge.

Multi: _____

7/1/09

20A-02



MODULAR METAL FABRICATORS INC.

Saddle Tap / Flat - 90°

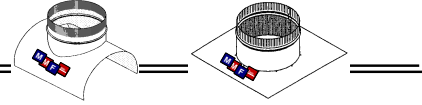

BRANCH SIZE	GA	LIST PRICE	PART NUMBER	PART NUMBER	LIST PRICE	PART NUMBER	PART NUMBER
		LESS DAMPER	90° ON SADDLE	90° ON FLAT	WITH DAMPER	90° ON SADDLE	90° ON FLAT
4"	28	\$8.77	STAH04	STAH04F	\$14.38	STAH04_D	STAH04FD
5"	28	\$9.33	STAH05	STAH05F	\$15.15	STAH05_D	STAH05FD
6"	28	\$10.16	STAH06	STAH06F	\$16.30	STAH06_D	STAH06FD
7"	28	\$11.44	STAH07	STAH07F	\$17.96	STAH07_D	STAH07FD
8"	28	\$12.48	STAH08	STAH08F	\$19.45	STAH08_D	STAH08FD
9"	28	\$13.59	STAH09	STAH09F	\$20.98	STAH09_D	STAH09FD
10"	28	\$14.77	STAH10	STAH10F	\$22.70	STAH10_D	STAH10FD
12"	26	\$16.50	STAI12	STAI12F	\$25.62	STAI12_D	STAI12FD
14"	26	\$18.23	STAI14	STAI14F	\$28.08	STAI14_D	STAI14FD
16"	26	\$20.56	STAI16	STAI16F	\$31.30	STAI16_D	STAI16FD
18"	26	\$24.41	STAI18	STAI18F	\$36.78	STAI18_D	STAI18FD
20"	24	\$29.95	STAJ20	STAJ20F	\$44.17	STAJ20_D	STAJ20FD
22"	24	\$35.64	STAJ22	STAJ22F	\$51.24	STAJ22_D	STAJ22FD
24"	24	\$47.08	STAJ24	STAJ24F	\$64.72	STAJ24_D	STAJ24FD
26"	24	\$56.92	STAJ26	STAJ26F	\$76.78	STAJ26_D	STAJ26FD

ALL DAMPERS INSTALLED IN SADDLE TAPS WILL BE STANDARD GAUGE UNLESS OTHERWISE SPECIFIED.

PLEASE STATE SADDLE SIZE WHEN ORDERING.

Saddle Tap / Flat - 45°

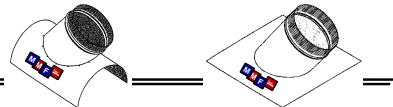

BRANCH SIZE	GA	LIST PRICE	PART NUMBER	PART NUMBER	LIST PRICE	PART NUMBER	PART NUMBER
		LESS DAMPER	45° ON SADDLE	45° ON FLAT	WITH DAMPER	45° ON SADDLE	45° ON FLAT
4"	28	\$8.77	STBH04	STBH04F	\$14.38	STBH04_D	STBH04FD
5"	28	\$9.33	STBH05	STBH05F	\$15.15	STBH05_D	STBH05FD
6"	28	\$10.16	STBH06	STBH06F	\$16.30	STBH06_D	STBH06FD
7"	28	\$11.44	STBH07	STBH07F	\$17.96	STBH07_D	STBH07FD
8"	28	\$12.48	STBH08	STBH08F	\$19.45	STBH08_D	STBH08FD
9"	28	\$13.59	STBH09	STBH09F	\$20.98	STBH09_D	STBH09FD
10"	28	\$14.77	STBH10	STBH10F	\$22.70	STBH10_D	STBH10FD
12"	26	\$16.50	STBI12	STBI12F	\$25.62	STBI12_D	STBI12FD
14"	26	\$18.23	STBI14	STBI14F	\$28.08	STBI14_D	STBI14FD
16"	26	\$20.56	STBI16	STBI16F	\$31.30	STBI16_D	STBI16FD
18"	26	\$24.41	STBI18	STBI18F	\$36.78	STBI18_D	STBI18FD
20"	24	\$29.95	STBJ20	STBJ20F	\$44.17	STBJ20_D	STBJ20FD
22"	24	\$35.64	STBJ22	STBJ22F	\$51.24	STBJ22_D	STBJ22FD
24"	24	\$47.08	STBJ24	STBJ24F	\$64.72	STBJ24_D	STBJ24FD
26"	24	\$56.92	STBJ26	STBJ26F	\$76.78	STBJ26_D	STBJ26FD

PLEASE STATE SADDLE SIZE WHEN ORDERING.

WYE Branches - Bead & Crimp One End/ Dovetail Other

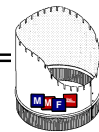

SIZE	GA	LIST PRICE	PART NUMBER	SIZE	GAUGE	LIST PRICE	PART NUMBER
4"	30	\$2.73	TYBG04	14"	28	\$8.90	TYBH14
5"	30	\$3.00	TYBG05	16"	28	\$11.20	TYBH16
6"	30	\$3.43	TYBG06	18"	28	\$13.03	TYBH18
7"	30	\$4.00	TYBG07	20"	26	\$14.87	TYBI20
8"	30	\$4.27	TYBG08	22"	26	\$16.93	TYBI22
9"	30	\$4.50	TYBG09	24"	26	\$19.30	TYBI24
10"	30	\$5.27	TYBG10	26"	24	\$22.00	TYBJ26
12"	30	\$6.97	TYBG12				

Multi: _____

7/1/09

r8/18/2011

21A-03



MODULAR METAL FABRICATORS INC.

Dampers Installed in Wyes and Collars

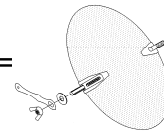

SIZE	LIST PRICE			
	30 GA	28 GA	26 GA	24 GA
5"	\$7.47	\$8.23	\$8.77	\$10.00
6"	\$7.90	\$8.73	\$9.27	\$10.63
7"	\$8.37	\$9.23	\$9.77	\$11.17
8"	\$8.70	\$9.57	\$10.20	\$11.60
9"	\$9.63	\$10.60	\$11.30	\$13.00
10"	\$10.33	\$11.37	\$12.10	\$13.83
12"		\$12.37	\$13.23	\$15.17
14"		\$13.40	\$14.27	\$16.47
16"		\$14.27	\$15.30	\$17.73
18"		\$16.70	\$16.70	\$21.27
20"			\$18.10	\$24.77
22"			\$19.63	\$28.30
24"			\$21.17	\$31.87
26"				\$35.50

INCLUDES:
2 BEARINGS
1 HANDLE
2 WASHERS
2 WING NUTS.
AVAILABLE IN
OTHER
HARDWARE,
PLEASE CALL
FOR PRICING.

Add to Register / Floor / Ceiling Box 30 Gauge

BOX SIZE	LIST PRICE					Collar SIZE	ROUND DAMPER Welded in Collar
	EARS	DUAL BOX	SPLITTER	DAMPER/BOX			
8"	\$0.53	\$0.90	\$1.43	\$1.43		4"	\$0.99
10"	\$0.53	\$0.93	\$1.60	\$1.60		5"	\$1.24
12"	\$0.53	\$1.13	\$1.77	\$1.70		6"	\$1.46
14"	\$0.53	\$1.30	\$1.90	\$1.80		7"	\$1.51
16"	\$0.53	\$1.83	\$2.17	\$2.10		8"	\$1.79
18"	\$0.53	\$2.40	\$2.83	\$2.60		9"	\$2.01
20"	\$0.53	\$2.87	\$3.43	\$2.90		10"	\$2.42
						12"	\$2.56

Round End Caps - 2" High

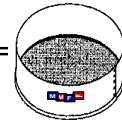

SIZE	LIST PRICE	PART NUMBER	LIST PRICE	PART NUMBER	LIST PRICE	PART NUMBER	LIST PRICE	PART NUMBER
	30 GA		28 GA		26 GA		24GA	
4"	\$3.27	ECG04	\$3.63	ECH04	\$3.80	ECI04	\$4.43	ECJ04
5"	\$3.63	ECG05	\$4.07	ECH05	\$4.23	ECI05	\$4.97	ECJ05
6"	\$4.03	ECG06	\$4.53	ECH06	\$4.73	ECI06	\$5.53	ECJ06
7"	\$4.60	ECG07	\$5.17	ECH07	\$5.40	ECI07	\$6.33	ECJ07
8"	\$5.10	ECG08	\$5.70	ECH08	\$5.97	ECI08	\$6.97	ECJ08
9"	\$5.70	ECG09	\$6.40	ECH09	\$6.67	ECI09	\$7.80	ECJ09
10"	\$6.37	ECG10	\$7.13	ECH10	\$7.43	ECI10	\$8.70	ECJ10
12"	\$7.83	ECG12	\$8.77	ECH12	\$9.13	ECI12	\$10.70	ECJ12
14"			\$9.80	ECH14	\$10.87	ECI14	\$12.67	ECJ14
16"			\$12.07	ECH16	\$13.37	ECI16	\$15.53	ECJ16
18"			\$15.00	ECH18	\$16.63	ECI18	\$19.33	ECJ18
20"					\$18.80	ECI20	\$22.73	ECJ20
22"					\$22.87	ECI22	\$27.63	ECJ22
24"					\$27.30	ECI24	\$33.03	ECJ24
26"							\$33.57	ECJ26

PLEASE SPECIFY NOMINAL OR UNDER-SIZED WHEN ORDERING

Multi: _____

7/1/09

r5/1/10

22A-03



MODULAR METAL FABRICATORS INC.

Stock Tapers - 8" High with Bead

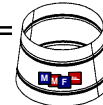

SIZE	GAUGE	LIST PART		SIZE	GAUGE	LIST PART	
		PRICE	NUMBER			PRICE	NUMBER
4 x 3	30	\$2.53	TPG040308	10 x 8	30	\$5.27	TPG100808
5 x 4	30	\$2.53	TPG050408	10 x 9	30	\$5.27	TPG100908
6 x 4	30	\$3.00	TPG060408	12 x 8	30	\$5.90	TPG120808
6 x 5	30	\$3.00	TPG060508	12 x 9	30	\$5.90	TPG120908
7 x 5	30	\$3.60	TPG070508	12 x 10	30	\$5.90	TPG121008
7 x 6	30	\$3.60	TPG070608	14 x 10	28	\$6.90	TPH141008
8 x 6	30	\$3.87	TPG080608	14 x 12	28	\$6.90	TPH141208
8 x 7	30	\$3.87	TPG080708	16 x 12	28	\$8.27	TPH161208
9 x 7	30	\$4.57	TPG090708	16 x 14	28	\$8.27	TPH161408
9 x 8	30	\$4.57	TPG090808	18 x 14	28	\$9.77	TPH181408
10 x 7	30	\$5.27	TPG100708	18 x 16	28	\$10.33	TPH181608

ALL TAPERS PRICED BY LARGE END.
PLEASE CALL FOR PRICING ON COLLARS BOTH ENDS.

Non-Stock Tapers - 8" High with Bead

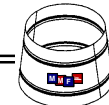

SIZE	LIST PRICE PART		LIST PRICE PART		LIST PRICE PART		LIST PRICE PART	
	30 GA	NUMBER	28 GA	NUMBER	26 GA	NUMBER	24 GA	NUMBER
5"	\$2.67	TPG05__08	\$2.97	TPH05__08	\$3.33	TPI05__08	\$3.83	TPJ05__08
6"	\$3.20	TPG06__08	\$3.50	TPH06__08	\$3.93	TPI06__08	\$4.53	TPJ06__08
7"	\$3.83	TPG07__08	\$4.20	TPH07__08	\$4.77	TPI07__08	\$5.47	TPJ07__08
8"	\$4.13	TPG08__08	\$4.53	TPH08__08	\$5.13	TPI08__08	\$5.83	TPJ08__08
9"	\$4.83	TPG09__08	\$5.47	TPH09__08	\$6.23	TPI09__08	\$7.40	TPJ09__08
10"	\$5.27	TPG10__08	\$6.27	TPH10__08	\$7.03	TPI10__08	\$8.10	TPJ10__08
12"	\$6.27	TPG12__08	\$6.90	TPH12__08	\$7.80	TPI12__08	\$8.97	TPJ12__08
14"			\$7.33	TPH14__08	\$8.37	TPI14__08	\$9.67	TPJ14__08
16"			\$8.80	TPH16__08	\$10.00	TPI16__08	\$11.60	TPJ16__08
18"			\$10.33	TPH18__08	\$11.70	TPI18__08	\$13.60	TPJ18__08
20"			\$12.57	TPH20__08	\$13.30	TPI20__08	\$16.47	TPJ20__08
22"					\$16.13	TPI22__08	\$17.43	TPJ22__08
24"					\$18.00	TPI24__08	\$19.90	TPJ24__08

Non-Stock Tapers - 12" High with Bead



SIZE	LIST PRICE PART		LIST PRICE PART		LIST PRICE PART		LIST PRICE PART	
	30 GA	NUMBER	28 GA	NUMBER	26 GA	NUMBER	24 GA	NUMBER
5"	\$3.20	TPG05__12	\$3.20	TPH05__12	\$3.73	TPI05__12	\$4.23	TPJ05__12
6"	\$3.73	TPG06__12	\$3.77	TPH06__12	\$4.40	TPI06__12	\$5.07	TPJ06__12
7"	\$4.40	TPG07__12	\$4.87	TPH07__12	\$5.17	TPI07__12	\$5.93	TPJ07__12
8"	\$4.77	TPG08__12	\$5.27	TPH08__12	\$5.57	TPI08__12	\$6.60	TPJ08__12
9"	\$5.50	TPG09__12	\$6.57	TPH09__12	\$7.33	TPI09__12	\$8.23	TPJ09__12
10"	\$6.23	TPG10__12	\$7.27	TPH10__12	\$7.90	TPI10__12	\$8.87	TPJ10__12
12"	\$7.43	TPG12__12	\$8.00	TPH12__12	\$8.87	TPI12__12	\$9.90	TPJ12__12
14"			\$8.63	TPH14__12	\$9.43	TPI14__12	\$10.87	TPJ14__12
16"			\$12.00	TPH16__12	\$12.77	TPI16__12	\$14.90	TPJ16__12
18"			\$14.80	TPH18__12	\$16.77	TPI18__12	\$21.53	TPJ18__12
20"			\$17.57	TPH20__12	\$21.97	TPI20__12	\$24.03	TPJ20__12
22"					\$24.13	TPI22__12	\$26.23	TPJ22__12
24"					\$27.03	TPI24__12	\$29.80	TPJ24__12
26"							\$35.07	TPJ26__12

Multi: _____

Effective 1/1/07

7/1/09

r1/1/07

23A-03



MODULAR METAL FABRICATORS INC.

Non-Stock Tapers - 18" High with Bead

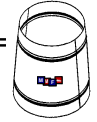

SIZE	LIST		LIST		LIST		LIST	
	PRICE	PART	PRICE	PART	PRICE	PART	PRICE	PART
	30 GA	NUMBER	28 GA	NUMBER	26 GA	NUMBER	24 GA	NUMBER
5"	\$3.53	TPG05 __ 18	\$3.87	TPH05 __ 18	\$4.13	TPI05 __ 18	\$5.07	TPJ05 __ 18
6"	\$4.07	TPG06 __ 18	\$4.47	TPH06 __ 18	\$4.77	TPI06 __ 18	\$5.73	TPJ06 __ 18
7"	\$4.80	TPG07 __ 18	\$5.33	TPH07 __ 18	\$5.67	TPI07 __ 18	\$6.43	TPJ07 __ 18
8"	\$5.23	TPG08 __ 18	\$5.73	TPH08 __ 18	\$6.10	TPI08 __ 18	\$7.23	TPJ08 __ 18
9"	\$6.40	TPG09 __ 18	\$7.03	TPH09 __ 18	\$7.30	TPI09 __ 18	\$8.83	TPJ09 __ 18
10"	\$7.23	TPG10 __ 18	\$7.97	TPH10 __ 18	\$8.43	TPI10 __ 18	\$9.67	TPJ10 __ 18
12"	\$8.00	TPG12 __ 18	\$8.80	TPH12 __ 18	\$9.37	TPI12 __ 18	\$10.70	TPJ12 __ 18
14"			\$9.37	TPH14 __ 18	\$10.03	TPI14 __ 18	\$12.00	TPJ14 __ 18
16"			\$13.43	TPH16 __ 18	\$14.17	TPI16 __ 18	\$15.97	TPJ16 __ 18
18"			\$16.20	TPH18 __ 18	\$17.97	TPI18 __ 18	\$22.33	TPJ18 __ 18
20"			\$18.97	TPH20 __ 18	\$24.13	TPI20 __ 18	\$26.13	TPJ20 __ 18
22"					\$26.37	TPI22 __ 18	\$28.97	TPJ22 __ 18
24"					\$28.33	TPI24 __ 18	\$32.67	TPJ24 __ 18
26"							\$36.33	TPJ26 __ 18

Non-Stock Tapers - 24" High with Bead



SIZE	LIST		LIST		LIST		LIST	
	PRICE	PART	PRICE	PART	PRICE	PART	PRICE	PART
	30 GA	NUMBER	28 GA	NUMBER	26 GA	NUMBER	24 GA	NUMBER
12"			\$11.00	TPH12 __ 24	\$11.70	TPI12 __ 24	\$13.40	TPJ12 __ 24
14"			\$11.70	TPH14 __ 24	\$12.50	TPI14 __ 24	\$15.00	TPJ14 __ 24
16"			\$16.80	TPH16 __ 24	\$17.70	TPI16 __ 24	\$19.97	TPJ16 __ 24
18"			\$20.63	TPH18 __ 24	\$22.50	TPI18 __ 24	\$27.90	TPJ18 __ 24
20"					\$29.00	TPI20 __ 24	\$32.67	TPJ20 __ 24
22"					\$32.93	TPI22 __ 24	\$36.23	TPJ22 __ 24
24"					\$35.43	TPI24 __ 24	\$40.80	TPJ24 __ 24
26"					\$38.17	TPI26 __ 24	\$43.93	TPJ26 __ 24

ALL TAPERS PRICED BY LARGE END. PLEASE CALL FOR PRICING ON COLLARS BOTH ENDS.

Three Piece Reducers / Increases



SIZE	TO	LIST		LIST		LIST		LIST	
		PRICE	PART	PRICE	PART	PRICE	PART	PRICE	PART
		30 GA	NUMBER	28 GA	NUMBER	26 GA	NUMBER	24 GA	NUMBER
4"	2-3	\$5.34	TPRG04 __ 09C	\$5.96	TPRH04 __ 09C	\$6.24	TPRI04 __ 09C	\$7.28	TPRJ04 __ 09C
5"	3-4	\$4.50	TPRG05 __ 09C	\$5.02	TPRH05 __ 09C	\$5.30	TPRI05 __ 09C	\$6.21	TPRJ05 __ 09C
6"	3-5	\$4.99	TPRG06 __ 09C	\$5.54	TPRH06 __ 09C	\$5.82	TPRI06 __ 09C	\$6.83	TPRJ06 __ 09C
7"	5-6	\$5.06	TPRG07 __ 09C	\$5.65	TPRH07 __ 09C	\$5.93	TPRI07 __ 09C	\$6.97	TPRJ07 __ 09C
8"	4-7	\$5.62	TPRG08 __ 09C	\$6.24	TPRH08 __ 09C	\$6.58	TPRI08 __ 09C	\$7.70	TPRJ08 __ 09C
9"	5-8	\$5.90	TPRG09 __ 09C	\$6.58	TPRH09 __ 09C	\$6.94	TPRI09 __ 09C	\$8.11	TPRJ09 __ 09C
10"	5-9	\$6.14	TPRG10 __ 09C	\$6.79	TPRH10 __ 09C	\$7.14	TPRI10 __ 09C	\$8.39	TPRJ10 __ 09C
12"	6-10	\$7.38	TPRG12 __ 09C	\$8.18	TPRH12 __ 09C	\$8.60	TPRI12 __ 09C	\$10.09	TPRJ12 __ 09C
14"	6-12			\$9.26	TPRH14 __ 09C	\$10.26	TPRI14 __ 09C	\$11.96	TPRJ14 __ 09C
16"	9-14			\$13.73	TPRH16 __ 09C	\$15.22	TPRI16 __ 09C	\$17.68	TPRJ16 __ 09C
18"	10-16			\$15.39	TPRH18 __ 09C	\$17.09	TPRI18 __ 09C	\$19.86	TPRJ18 __ 09C
20"	10-18					\$17.96	TPRI20 __ 09C	\$23.09	TPRJ20 __ 09C
22"	14-20					\$46.80	TPRI22 __ 09C	\$56.61	TPRJ22 __ 09C
24"	16-22					\$58.48	TPRI24 __ 09C	\$70.79	TPRJ24 __ 09C
26"	18-24							\$73.11	TPRJ26 __ 09C

SIZES NOT SHOWN ARE SUBJECT TO A \$25.00 PATTERN CHARGE.

Standard Description

Large End : Nominal

Small End : Crimped

*** Standard Description -- Large End : Nominal ** Small End : Crimped ***
Please Call For Quote On Styles Not Shown

Multi: _____ Effective 1/1/07 7/1/09 r1/1/07 24A-03



MODULAR METAL FABRICATORS INC.

1" Circle Lined Tapers - 8" High

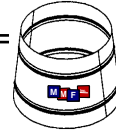

SIZE	LIST PRICE	PART NUMBER	LIST PRICE	PART NUMBER	LIST PRICE	PART NUMBER
	28 GA		26 GA		24 GA	
8 x 7	\$15.53	TPCLH080708	\$16.13	TPCLI080708	\$16.83	TPCLJ080708
9 x 8	\$16.84	TPCLH090808	\$17.60	TPCLI090808	\$18.77	TPCLJ090808
10 x 6	\$17.83	TPCLH100608	\$18.67	TPCLI100608	\$19.67	TPCLJ100608
10 x 8	\$17.83	TPCLH100808	\$18.67	TPCLI100808	\$19.67	TPCLJ100808
10 x 9	\$17.83	TPCLH100908	\$18.67	TPCLI100908	\$19.67	TPCLJ100908
12 x 8	\$19.47	TPCLH120808	\$20.33	TPCLI120808	\$21.50	TPCLJ120808
12 x 10	\$19.47	TPCLH121008	\$20.33	TPCLI121008	\$21.50	TPCLJ121008
14 x 10	\$20.40	TPCLH141008	\$21.44	TPCLI141008	\$22.47	TPCLJ141008
14 x 12	\$20.40	TPCLH141208	\$21.44	TPCLI141208	\$22.47	TPCLJ141208
16 x 14	\$23.07	TPCLH161408	\$24.27	TPCLI161408	\$25.87	TPCLJ161408
18 x 16			\$28.73	TPCLI181608	\$30.63	TPCLJ181608
20 x 18			\$35.63	TPCLI201808	\$38.80	TPCLJ201808

** NOTICE **
 Catalog pricing is based on "standard pack" quantity.
 Non "standard pack" quantity orders may be subject to an additional charge.

Multi: _____

Effective 1/1/07

7/1/09

r1/1/07

24AA-03



MODULAR METAL FABRICATORS INC.

**Galvanized Plenums, Add Cap for Plenum,
Sleeves - KD Priced Per Girth Inch
Sizes are Rounded to Next Whole Size**

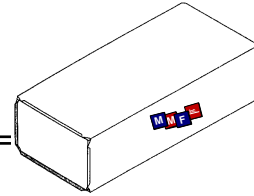

HEIGHT	LIST PRICE					
	28 GA BARE	26 G BARE	24 GA BARE	22 GA BARE	ADD FO 1" LINER	ADD FO 1 1/2" LINER
12"	\$0.210	\$0.247	\$0.307	\$0.323	\$0.147	\$0.193
14"	\$0.230	\$0.270	\$0.337	\$0.353	\$0.173	\$0.223
16"	\$0.247	\$0.290	\$0.360	\$0.380	\$0.197	\$0.253
18"	\$0.270	\$0.317	\$0.393	\$0.413	\$0.223	\$0.290
20"	\$0.290	\$0.343	\$0.427	\$0.447	\$0.247	\$0.320
22"	\$0.310	\$0.367	\$0.453	\$0.477	\$0.273	\$0.353
24"	\$0.327	\$0.383	\$0.477	\$0.503	\$0.297	\$0.383
26"	\$0.353	\$0.413	\$0.517	\$0.543	\$0.323	\$0.420
28"	\$0.387	\$0.457	\$0.567	\$0.597	\$0.347	\$0.450
30"	\$0.410	\$0.480	\$0.597	\$0.630	\$0.370	\$0.480
32"	\$0.430	\$0.507	\$0.630	\$0.663	\$0.397	\$0.513
34"	\$0.447	\$0.527	\$0.653	\$0.687	\$0.417	\$0.543
36"	\$0.463	\$0.547	\$0.680	\$0.713	\$0.443	\$0.580
38"	\$0.487	\$0.570	\$0.713	\$0.747	\$0.470	\$0.610
40"	\$0.510	\$0.597	\$0.743	\$0.783	\$0.490	\$0.640
42"	\$0.553	\$0.653	\$0.807	\$0.853	\$0.517	\$0.673
44"	\$0.573	\$0.660	\$0.843	\$0.887	\$0.543	\$0.703
46"	\$0.603	\$0.710	\$0.883	\$0.930	\$0.567	\$0.740
48"	\$0.647	\$0.760	\$0.947	\$0.993	\$0.593	\$0.770
CAP	\$0.110	\$0.127	\$0.157	\$0.167	\$0.057	\$0.073

Collars Installed in Plenum(s) and Sleeves

COLLAR	LIST PRICE			
	28 GA	26 GA	24 GA	22 GA
12"	\$8.27	\$12.10	\$12.73	\$19.13
14-18"	\$10.13	\$14.83	\$15.57	\$23.37
20-26"	\$11.37	\$16.63	\$17.53	\$26.27
28-30"	\$15.17	\$22.20	\$23.40	\$35.13
32-36"	\$18.17	\$26.63	\$28.13	\$42.20

**FOR TURNING VANE
INSTALLED --
PLEASE CALL FOR
PRICING.**

**TRANSITIONAL ADD 87%
FILTER RACK ADD 30%
ASSEMBLED ADD 10%**

**** NOTICE ****
Catalog pricing is based on "standard pack" quantity.
Non "standard pack" quantity orders may be subject to additional charges.

Multi: _____

7/1/09

R5/1/10

25A-03



MODULAR METAL FABRICATORS INC.

Plaster Ground Frames - 30 Gauge

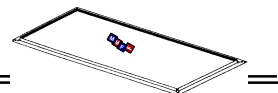

SIZE	LIST PRICE x 24"	PART NUMBER	LIST PRICE x 30"	PART NUMBER	LIST PRICE x 36"	PART NUMBER
6"	\$4.60	MPFG2406	\$5.53	MPFG3006	\$6.43	MPFG3606
8"	\$4.83	MPFG2408	\$5.83	MPFG3008	\$6.73	MPFG3608
10"	\$5.17	MPFG2410	\$6.10	MPFG3010	\$7.13	MPFG3610
12"	\$5.47	MPFG2412	\$6.40	MPFG3012	\$7.33	MPFG3612
14"	\$5.83	MPFG2414	\$6.70	MPFG3014	\$7.70	MPFG3614
16"	\$6.10	MPFG2416	\$6.97	MPFG3016	\$7.93	MPFG3616
18"	\$6.43	MPFG2418	\$7.27	MPFG3018	\$8.23	MPFG3618

Plaster Ground

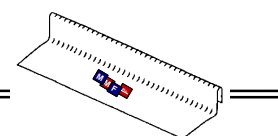

SIZE	LIST PRICE 30 GA	PART NUMBER	LIST PRICE 28 GA	PART NUMBER	LIST PRICE 26 GA	PART NUMBER	LIST PRICE 24 GA	PART NUMBER
8'L	\$2.72	MPPG08	\$4.08	MPPH08	\$4.24	MPPI08	\$4.94	MPPJ08
9'L	\$4.08	MPPG09	\$4.59	MPPH09	\$4.77	MPPI09	\$5.55	MPPJ09
10'L	\$3.11	MPPG10	\$3.21	MPPH10	\$3.82	MPPI10	\$4.63	MPPJ10

Standard Pack 10/Bundle

S'Lock

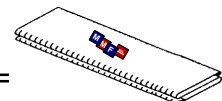

SIZE	LIST PRICE 30 GA	PART NUMBER	LIST PRICE 28 GA	PART NUMBER	LIST PRICE 26 GA	PART NUMBER	LIST PRICE 24 GA	PART NUMBER
8'L	\$2.22	MPSG08	\$6.40	MPSH08	\$6.70	MPSI08	\$7.70	MPSJ08
9'L	\$6.37	MPSG09	\$7.20	MPSH09	\$7.53	MPSI09	\$8.67	MPSJ09
10'L	\$2.78	MPSG10	\$2.97	MPSH10	\$3.56	MPSI10	\$4.55	MPSJ10

Standard Pack 10/Bundle

Drives

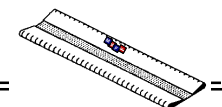

SIZE	LIST PRICE 30 GA	PART NUMBER	LIST PRICE 28 GA	PART NUMBER	LIST PRICE 26 GA	PART NUMBER	LIST PRICE 24 GA	PART NUMBER
8'L	\$1.54	MPDG08	\$4.07	MPDH08	\$4.20	MPDI08	\$4.93	MPDJ08
9'L	\$4.10	MPDG09	\$4.57	MPDH09	\$4.73	MPDI09	\$5.53	MPDJ09
10'L	\$1.73	MPDG10	\$1.77	MPDH10	\$2.05	MPDI10	\$2.60	MPDJ10

Standard Pack 10/Bundle

**** NOTICE **** Catalog pricing is based on "standard pack" quantity.
Non "standard pack" quantity orders may be subject to additional charge.

Multi: _____

7/1/09

r10/1/09

26A-03



MODULAR METAL FABRICATORS INC.

Standing S

Prices effective 1/5/09

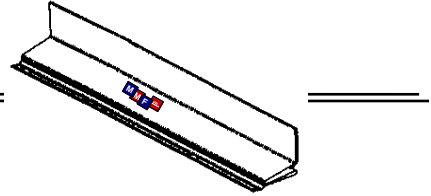

LIST PRICE	PART NUMBER	LIST PRICE	PART NUMBER
24 GA		22 GA	
7.38	MPSSJ10	8.37	MPSSK10

Standard Pack 5/Bundle

**** NOTICE **** Catalog pricing is based on "standard pack" quantity.
Non "standard pack" quantity orders are subject to an additional charge.

Multi: _____

7/1/09

r10/1/09

27A-03



MODULAR METAL FABRICATORS INC.

Round Plenum - Cap One End / Raw

SIZE	NET PRICE 28 GA	PART NUMBER	SIZE	NET PRICE 28 GA	PART NUMBER
10" RD x 18" HIGH	\$9.41	ACPRH1018	14" RD x 30" HIGH	\$16.10	ACPRH1430
10" RD x 30" HIGH	\$11.35	ACPRH1030	16" RD x 18" HIGH	\$14.16	ACPRH1618
12" RD x 18" HIGH	\$11.24	ACPRH1218	16" RD x 30" HIGH	\$18.63	ACPRH1630
12" RD x 30" HIGH	\$13.90	ACPRH1230	18" RD x 18" HIGH	\$17.98	ACPRH1818
14" RD x 18" HIGH	\$13.27	ACPRH1418	18" RD x 30" HIGH	\$21.50	ACPRH1830

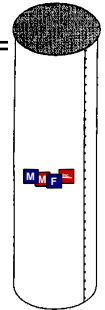

Combustion Air Can - Rectangular

SIZE	NET PRICE 30 GA	PART NUMBER
3 1/4" x 14" x 8" HIGH W/1/4" HDW Cloth - Raw	\$2.84	ACBG031408D
4" x 14" x 8" HIGH W/1/4" HDW Cloth - 5/8" PG	\$3.24	ACBG041408E
6" x 14" x 8" HIGH W/1/4" HDW Cloth - 5/8" PG	\$3.67	ACBG061408E
3 1/4" x 14" x 7" HIGH W/1/4" HDW Cloth - Raw	\$4.82	ACBG031407D
4" x 14" x 11" HIGH W/1/4" HDW Cloth - 5/8" PG	\$3.99	ACBG041411E
6" x 14" x 11" HIGH W/1/4" HDW Cloth - 5/8" PG	\$4.50	ACBG061411E
3 1/4" x 14" x 11" HIGH W/1/4" HDW Cloth - Raw	\$3.49	ACBG031411D

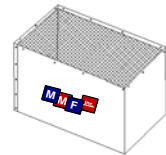

Combustion Air Can - Round

SIZE	LIST PRICE 30 GA	PART NUMBER
8" ROUND x 12" HIGH Raw	\$3.53	ACBG0812R
8" ROUND x 12" HIGH W/1/4" HDW Cloth	\$5.07	ACBG0812H
8" ROUND x 15" HIGH Raw	\$3.87	ACBG0815R
8" ROUND x 15" HIGH W/1/4" HDW Cloth	\$5.97	ACBG0815H

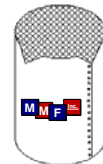

**HDW CLOTH =
HARDWARE
CLOTH OR MESH.**

Square to Round Transition - 6" High

SIZE	LIST PRICE 28 GA	PART NUMBER
19 1/4" x 12" to 12" RD	\$24.57	BTTHESCMCMA
19 1/4" x 12 1/4" to 14" RD	\$25.00	BTTHESCODCA
19 1/4" x 16" to 14" RD	\$27.70	BTTHESDSDCA
19 1/4" x 16" to 16" RD	\$27.70	BTTHESDSDSA
19 1/4" x 19 1/4" to 16" RD	\$30.30	BTTHESSEDSA
19 1/4" x 21" to 16" RD	\$31.57	BTTHFGESDSA
19 1/4" x 23" to 16" RD	\$33.17	BTTHFWESDSA
19 1/4" x 23" to 18" RD	\$33.17	BTTHFWESEIA

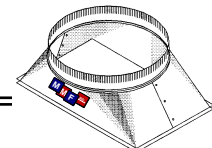

**PLEASE SPECIFY WHEN
ORDERING:
RAW, PG OR FLANGE
FOR SIZES NOT SHOWN, PLEASE
CALL FOR PRICING.**

Multi: _____

7/1/09

28A-03



MODULAR METAL FABRICATORS INC.

Return Air Cans with Cap - No Collar 28 Gauge - PG or Flange Bare, or 1" Liner

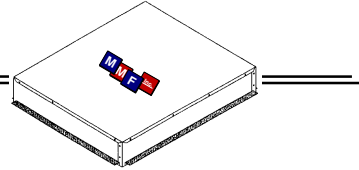

Size	LIST PRICE - NO COLLARS		
	4" HIGH	6" HIGH	9" HIGH
20.25" x 14.25"	\$14.80	\$17.70	\$21.13
20.25" x 16.25"	\$15.67	\$18.73	\$22.30
20.25" x 20.25"	\$17.40	\$20.83	\$24.80
20.25" x 25.25"	\$20.03	\$23.13	\$27.73
24.25" x 12.25"	\$15.67	\$18.73	\$22.30
24.25" x 14.25"	\$16.53	\$19.77	\$23.57
24.25" x 24.25"	\$20.80	\$25.03	\$29.67
25.25" x 14.25"	\$16.97	\$20.30	\$24.17
25.25" x 16.25"	\$17.83	\$21.33	\$25.40
25.25" x 18.25"	\$18.70	\$22.37	\$26.67
30.25" x 14.25"	\$19.17	\$22.93	\$27.30
30.25" x 20.25"	\$21.77	\$26.03	\$31.00
30.25" x 24.25"	\$23.50	\$28.13	\$33.47
PER GIRTH	\$0.217	\$0.260	\$0.310

ADD PER GIRTH INCH
FOR 1" LINER
4" HIGH: \$0.100
6" HIGH: \$0.130
9" HIGH: \$0.273

26 or 24 GAUGE
or OVAL COLLARS
Call for Quote.

Return Air Cans with Cap - With Collar 28 Gauge - PG or Flange Bare, or 1" Liner

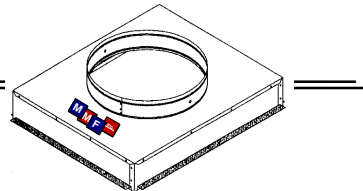

Size	LIST PRICE - WITH COLLARS		
	4" HIGH	6" HIGH	9" HIGH
20.25" x 14.25"	\$16.53	\$19.93	\$24.33
20.25" x 16.25"	\$17.03	\$21.07	\$25.77
20.25" x 20.25"	\$18.90	\$23.43	\$28.63
20.25" x 25.25"	\$21.57	\$26.20	\$32.37
24.25" x 12.25"	\$17.03	\$21.07	\$25.77
24.25" x 14.25"	\$18.47	\$22.27	\$27.20
24.25" x 24.25"	\$23.40	\$28.20	\$34.30
25.25" x 14.25"	\$18.97	\$22.83	\$27.90
25.25" x 16.25"	\$19.93	\$24.00	\$29.37
25.25" x 18.25"	\$20.90	\$25.20	\$30.77
30.25" x 14.25"	\$21.40	\$25.77	\$31.50
30.25" x 20.25"	\$24.33	\$29.27	\$35.80
30.25" x 24.25"	\$26.27	\$31.63	\$38.63
PER GIRTH	\$0.243	\$0.293	\$0.357

ADD PER GIRTH INCH
FOR 1" LINER
4" HIGH: \$0.100
6" HIGH: \$0.130
9" HIGH: \$0.173

26 or 24 GAUGE
or OVAL COLLARS
Call for Quote.

PLEASE STATE - RAW - PG - FLANGE WHEN ORDERING

Multi: _____

7/1/09

R5/1/10

29A-03

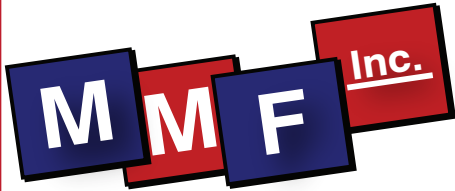

PRODUCT SPECIFICATIONS

MODULAR METAL FABRICATORS INC.

M-Filter Bases

DESCRIPTION:

M-Filter Bases are manufactured by Modular Metal Fabricators out of galvanized sheet metal to precise dimensions for the residential and light commercial HVAC market.

M-Filter Bases allow for convenient changing of filters without removing furnace door by homeowners on a regular basis. These bases are used in up-flow, down-flow, and horizontal applications and are designed to accommodate a variety of filters. All Filter Bases have fully gasketed doors and spring loaded hinges.

1" Filter Base

PART NUMBER	DESCRIPTION	LIST EA.	SHIPPED
BRFBJ1420A	14 X 20 - FITS 1" FILTERS	36.95	1 PER BOX
BRFBJ1425A	14 X 25 - FITS 1" FILTERS	36.95	1 PER BOX
BRFBJ1620A	16 X 20 - FITS 1" FILTERS	39.12	1 PER BOX
BRFBJ1625A	16 X 25 - FITS 1" FILTERS	39.12	1 PER BOX
BRFBJ2020A	20 X 20 - FITS 1" FILTERS	39.85	1 PER BOX
BRFBJ2025A	20 X 25 - FITS 1" FILTERS	39.85	1 PER BOX
BRFBJ2424A	24 X 24 - FITS 1" FILTERS	48.47	1 PER BOX
BRFBJ3025A	30 X 25 - FITS 1" FILTERS	55.31	1 PER BOX

1" Filter Base



1" or 2" Filter Base

29A-03

PART NUMBER	DESCRIPTION	LIST EA.	SHIPPED
BRFBJ1420B	14 X 20 - FITS 1",2" FILTERS	41.99	1 PER BOX
BRFBJ1425B	14 X 25 - FITS 1",2" FILTERS	41.99	1 PER BOX
BRFBJ1620B	16 X 20 - FITS 1",2" FILTERS	43.65	1 PER BOX
BRFBJ1625B	16 X 25 - FITS 1",2" FILTERS	43.65	1 PER BOX
BRFBJ2020B	20 X 20 - FITS 1",2" FILTERS	44.85	1 PER BOX
BRFBJ2025B	20 X 25 - FITS 1",2" FILTERS	44.85	1 PER BOX
BRFBJ2424B	24 X 24 - FITS 1",2" FILTERS	54.76	1 PER BOX
BRFBJ3025B	30 X 25 - FITS 1",2" FILTERS	62.75	1 PER BOX

1" or 2" Filter Base

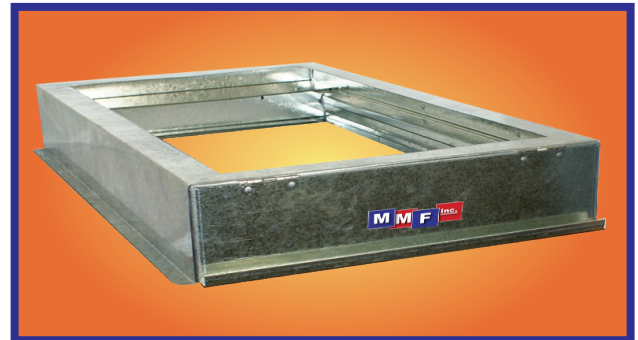

1", 2" or 4" Filter Base

PART NUMBER	DESCRIPTION	LIST EA.	SHIPPED
BRFBJ1420C	14 X 20 - FITS 1",2",4" FILTERS	48.73	1 PER BOX
BRFBJ1425C	14 X 25 - FITS 1",2",4" FILTERS	48.73	1 PER BOX
BRFBJ1620C	16 X 20 - FITS 1",2",4" FILTERS	50.64	1 PER BOX
BRFBJ1625C	16 X 25 - FITS 1",2",4" FILTERS	50.64	1 PER BOX
BRFBJ2020C	20 X 20 - FITS 1",2",4" FILTERS	52.86	1 PER BOX
BRFBJ2025C	20 X 25 - FITS 1",2",4" FILTERS	52.86	1 PER BOX
BRFBJ2424C	24 X 24 - FITS 1",2",4" FILTERS	57.80	1 PER BOX
BRFBJ3025C	30 X 25 - FITS 1",2",4" FILTERS	66.23	1 PER BOX

1", 2" or 4" Filter Base

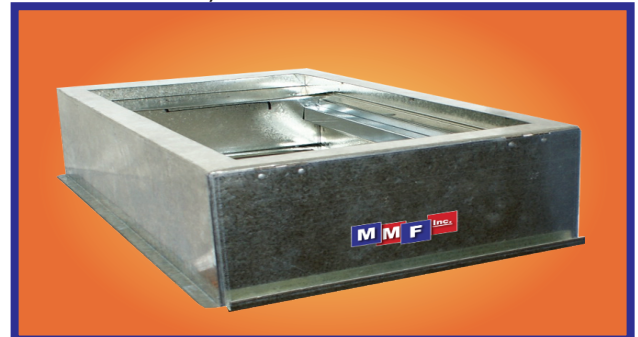

- A = 1" FILTER
- B = 1" OR 2" FILTER
- C = 1", 2" OR 4" FILTER

- Durable Galvanized Steel Construction.
- Integrated Door Handle.
- Spring Loaded Hinges.
- Bottom Cut-Outs for Easy Screw Installation.
- Fully Gasketed Door Opening

5/22/14

29AA-03



MODULAR METAL FABRICATORS INC.

Line Set Covers

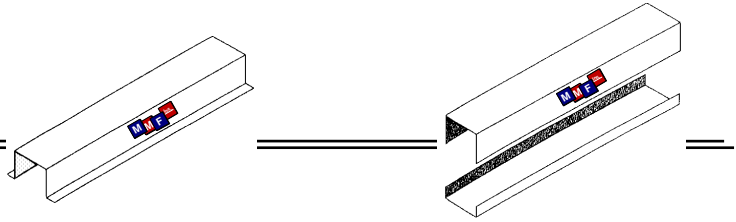

SIZE	LIST PRICE	PART NUMBER	LIST PRICE	PART NUMBER
	28 GA GALV		26 GA GALV	
ONE PIECE	\$14.53	MPLSC101PCH	\$16.25	MPLSC101PCI
TWO PIECE	\$17.70	MPLSC102PCH	\$19.64	MPLSC102PCI

SIZE	LIST PRICE	PART NUMBER	LIST PRICE	PART NUMBER
	24 GA GALV		28 GA BONDO	
ONE PIECE	\$18.87	MPLSC101PCJ	\$15.79	MPLSC101PCHH
TWO PIECE	\$22.85	MPLSC102PCJ	\$19.13	MPLSC102PCHH

Drain Pans - Per Girth Inch 2" High with 3/4" PVC Female Nipple, Soldered, 1/2" Hem

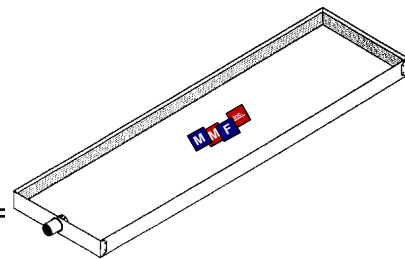

LIST PRICE				
30 GA	28 GA	26 GA	24 GA	22 GA
\$0.198	\$0.222	\$0.232	\$0.274	\$0.409

PLEASE SPECIFY LOCATION OF NIPPLE.

**** NOTICE ****
Catalog pricing is based on a "standard pack" quantity.
Non "standard pack" quantity orders may be subject to an additional charge.

Multi: _____

7/1/09

30A-03



MODULAR METAL FABRICATORS INC.

Modular Flex Duct R4.2 – R-6 – R-8 25 Foot Long - Black Jacket FDMA Series – Raw Ends

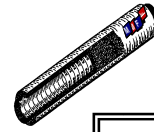

Size	R-4.2 LIST PRICE	R-4.2 PART NUMBER	R-6 LIST PRICE	R-6 PART NUMBER	R-8 LIST PRICE	R-8 PART NUMBER
	4"	\$22.00	FDMA2504	\$26.99	FDMAR62504	\$37.82
5"	\$25.56	FDMA2505	\$31.50	FDMAR62505	\$43.40	FDMAD2505
6"	\$28.59	FDMA2506	\$35.04	FDMAR62506	\$45.24	FDMAD2506
7"	\$31.13	FDMA2507	\$38.60	FDMAR62507	\$50.80	FDMAD2507
8"	\$33.95	FDMA2508	\$41.98	FDMAR62508	\$56.26	FDMAD2508
9"	\$38.23	FDMA2509	\$46.88	FDMAR62509	\$60.66	FDMAD2509
10"	\$42.60	FDMA2510	\$52.69	FDMAR62510	\$66.83	FDMAD2510
12"	\$52.80	FDMA2512	\$65.41	FDMAR62512	\$82.52	FDMAD2512
14"	\$64.11	FDMA2514	\$78.76	FDMAR62514	\$101.27	FDMAD2514
16"	\$74.43	FDMA2516	\$94.92	FDMAR62516	\$121.25	FDMAD2516
18"	\$84.58	FDMA2518	\$108.52	FDMAR62518	\$130.30	FDMAD2518
20"	\$103.09	FDMA2520	\$130.68	FDMAR62520		N/A

Polyester/Wire Helix Core.
Fiberglass Mesh Scrim.
Fiberglass Insulation.
FDMA: Durable Black Jacket
FDMD: Silver Jacket.

Modular Flex Duct R-4.2 - R-6 - R-8 25 Foot Long – Silver Jacket FDMD Series – Raw Ends

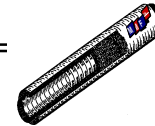

Size	R-4.2 LIST PRICE	R-4.2 PART NUMBER	R-6 LIST PRICE	R-6 PART NUMBER	R-8 LIST PRICE	R-8 PART NUMBER
	4"	\$24.94	FDMD2504	\$28.31	FDMDR62504	\$39.01
5"	\$29.16	FDMD2505	\$33.21	FDMDR60505	\$44.36	FDMDR82505
6"	\$32.85	FDMD2506	\$37.32	FDMDR62506	\$46.19	FDMDR82506
7"	\$35.78	FDMD2507	\$40.71	FDMDR62507	\$52.20	FDMDR82607
8"	\$39.01	FDMD2508	\$44.30	FDMDR62508	\$56.66	FDMDR82508
9"	\$44.11	FDMD2509	\$50.02	FDMDR62509	\$61.90	FDMDR82509
10"	\$48.86	FDMD2510	\$55.49	FDMDR62510	\$67.67	FDMDR82510
12"	\$58.75	FDMD2512	\$69.03	FDMDR62512	\$84.25	FDMDR82512
14"	\$71.21	FDMD2514	\$83.49	FDMDR62514	\$102.01	FDMDR82514
16"	\$85.53	FDMD2516	\$97.13	FDMDR62516	\$122.45	FDMDR82516
18"	\$97.88	FDMD2518	\$111.00	FDMDR62518	\$131.67	FDMDR82518
20"	\$122.16	FDMD2520	\$135.72	FDMDR62520	\$141.67	FDMDR82520

**** NOTICE ****
Catalog pricing is based on "standard pack" quantity. Non "standard pack" quantity orders may be subject to additional charge.

Flex Size	R-4.2		R-6		R-8		Flex Size	R-4.2		R-6		R-8	
	Cartons	Bale	Cartons	Bale	Cartons	Bale		Cartons	Bale	Cartons	Bale	Cartons	Bale
4"	25	25x42x42	25	25x46x46	16	35x41x43	10"	9	25x40x40	9	25x46x46	6	35x45x45
5"	25	25x42x42	25	25x46x46	16	35x41x43	12"	9	25x45x45	9	25x51x51	4	35x52x35
6"	25	25x46x46	25	25x50x50	16	35x45x45	14"	6	25x51x35	6	25x56x38	4	35x37x37
7"	16	25x41x41	16	25x45x45	16	35x49x49	16"	4	25x38x38	4	25x42x42	4	35x43x43
8"	16	25x45x45	16	25x48x48	9	35x40x40	18"	4	25x42x42	4	25x47x47	4	35x46x46
9"	16	25x48x48	16	25x52x52	9	35x43x43	20"	4	25x45x45	4	25x47x47	4	25x47x47

Multi _____

7/1/09

r7/24/12

31A-06



MODULAR METAL FABRICATORS INC.

Modular Flex Duct R-4.2 – R-6 – R-8 6 Foot Long *Black Jacket* – Collar Both Ends

Price Reduction Effective March 1, 2010

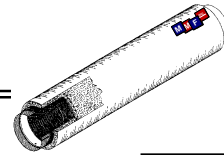

Size	R-4.2 LIST PRICE	R-4.2 PART NUMBER	R-6 LIST PRICE	R-6 PART NUMBER	R-8 LIST PRICE	R-8 PART NUMBER
4"	\$15.25	FDMB0604	\$17.62	FDMBR60604	\$18.17	FDMBR80604
5"	\$16.38	FDMB0605	\$19.47	FDMBR60605	\$24.03	FDMBR80605
6"	\$17.86	FDMB0606	\$20.98	FDMBR60606	\$26.00	FDMBR80606
7"	\$19.66	FDMB0607	\$23.70	FDMBR60607	\$27.91	FDMBR80607
8"	\$21.37	FDMB0608	\$25.30	FDMBR60608	\$28.71	FDMBR80608
9"	\$23.29	FDMB0609	\$27.82	FDMBR60609	\$32.03	FDMBR80609
10"	\$26.32	FDMB0610	\$30.71	FDMBR60610	\$33.56	FDMBR80610
12"	\$31.51	FDMB0614	\$36.43	FDMBR60612	\$38.84	FDMBR80612
14"	\$37.84	FDMB0614	\$43.78	FDMBR60614	\$46.13	FDMBR80614
16"	\$43.27	FDMB0616	\$49.36	FDMBR61616	\$50.98	FDMBR80616
18"	\$48.73	FDMB0618	\$59.08	FDMBR60618	\$64.18	FDMBR80618
20"	\$57.50	FDMB0620	\$70.24	FDMBR60620		N/A



Polyester/Wire Helix Core.
Fiberglass Mesh Scrim.
Fiberglass Insulation.
Durable Black Jacket.

Modular Flex Duct R4.2 – R-6 – R-8 6 Foot Long *Silver Jacket* _ Collar Both Ends

Price Reduction Effective March 1, 2010

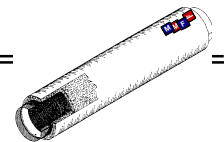

Size	R-4.2 LIST PRICE	R-4.2 PART NUMBER	R-6 LIST PRICE	R-6 PART NUMBER	R-8 LIST PRICE	R-8 PART NUMBER
4"	\$16.87	FDMD0604	\$17.98	FDMDDR60604	\$18.96	FDMDDR80604
5"	\$19.26	FDMD0605	\$20.43	FDMDDR60605	\$25.06	FDMDDR80605
6"	\$20.76	FDMD0606	\$22.00	FDMDDR60606	\$27.10	FDMDDR80606
7"	\$22.90	FDMD0607	\$24.28	FDMDDR60607	\$29.12	FDMDDR80607
8"	\$24.70	FDMD0608	\$26.18	FDMDDR60608	\$29.95	FDMDDR80608
9"	\$26.68	FDMD0609	\$28.27	FDMDDR60609	\$33.40	FDMDDR80609
10"	\$30.26	FDMD0610	\$32.07	FDMDDR60610	\$34.99	FDMDDR80610
12"	\$35.87	FDMD0612	\$39.29	FDMDDR60612	\$41.64	FDMDDR80612
14"	\$44.28	FDMD0614	\$45.99	FDMDDR60614	\$46.63	FDMDDR80614
16"	\$50.10	FDMD0616	\$52.04	FDMDDR60616	\$52.99	FDMDDR80616
18"	\$58.21	FDMD0618	\$61.71	FDMDDR60618	\$64.87	FDMDDR80618
20"	\$67.51	FDMD0620	\$69.41	FDMDDR60620	\$71.21	FDMDDR80620



Polyester/Wire Helix Core.
Fiberglass Mesh Scrim.
Fiberglass Insulation.
Silver Jacket.

Multi_____

7/1/09

r3/01/10

31AA-06



MODULAR METAL FABRICATORS INC.

Acoustical Core/Silver Jacket 25 Foot Long – R-4.2 – R-6 – R-8

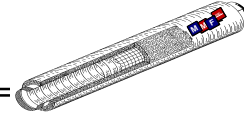

SIZE RD	LIST PRICE	R-4.2 PART NUMBER	R4.2 # PER CRTN.	LIST PRICE	R-6 PART NUMBER	R-6 # PER CRTN.	LIST PRICE	R-8 PART NUMBER	R-8 # PER CRTN.
	25'L			25'L			25'L		
4"	\$39.07	FDMDA2504	1	\$42.98	FDMDAR62504	1			1
5"	\$40.76	FDMDA2505	1	\$44.75	FDMDAR62505	1			1
6"	\$43.48	FDMDA2506	1	\$47.66	FDMDAR62506	1			1
7"	\$49.17	FDMDA2507	1	\$53.80	FDMDAR62507	1			1
8"	\$54.84	FDMDA2508	1	\$59.40	FDMDAR62508	1			1
9"	\$66.80	FDMDA2509	1	\$71.75	FDMDAR62509	1			1
10"	\$72.97	FDMDA2510	1	\$78.45	FDMDAR62510	1			1
12"	\$85.74	FDMDA2512	1	\$91.54	FDMDAR62512	1			1
14"	\$106.12	FDMDA2514	1	\$112.88	FDMDAR62514	1			1
16"	\$124.53	FDMDA2516	1	\$131.74	FDMDAR62516	1			1
18"	\$140.58	FDMDA2518	1	\$148.67	FDMDAR62518	1			1
20"	\$163.63	FDMDA2520	1	\$174.24	FDMDAR62520	1		N/A	

**ACOUSTICAL /
WIRE HELIX CORE
FIBERGLASS
THREADED MESH
SCRIM
FIBERGLASS
INSULATION
DURABLE
POLYETHYLENE
JACKET**

Acoustical Core/Silver Jacket 6 Foot Long - R4.2 - R-6 - R-8

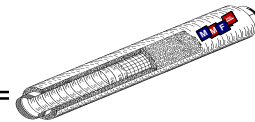

SIZE RD	LIST PRICE	R-4.2 PART NUMBER	R4.2 # PER CRTN.	LIST PRICE	R-6 PART NUMBER	R-6 # PER CRTN.	LIST PRICE	R-8 PART NUMBER	R-8 # PER CRTN.
	6'L			6'L			6'L		
4"	\$28.25	FDMDDA0604	2	\$21.93	FDMDDAR60604	2			2
5"	\$28.80	FDMDDA0605	2	\$25.07	FDMDDAR60605	2			2
6"	\$29.54	FDMDDA0606	2	\$26.61	FDMDDAR62506	2			2
7"	\$31.71	FDMDDA0607	2	\$29.07	FDMDDAR62507	2			2
8"	\$33.75	FDMDDA0608	2	\$31.66	FDMDDAR62508	2			2
9"	\$36.74	FDMDDA0609	2	\$35.39	FDMDDAR62509	2			2
10"	\$38.88	FDMDDA0610	2	\$37.32	FDMDDAR62510	2			2
12"	\$46.36	FDMDDA0612	2	\$44.62	FDMDDAR62512	2			2
14"	\$51.79	FDMDDA0614	2	\$52.02	FDMDDAR62514	2			2
16"	\$58.21	FDMDDA0616	2	\$63.27	FDMDDAR62516	2			2
18"	\$63.92	FDMDDA0618	2	\$67.63	FDMDDAR62518	2			2
20"	\$86.91	FDMDDA0620	2	\$80.03	FDMDDAR62520	2		N/A	



** NOTICE ** Catalog pricing is based on # PER CRTN. Broken CRTN. quantity order, and may be subject to additional charge.

Multi: _____

7/1/09

r1/12/09

32A-06



MODULAR METAL FABRICATORS INC.

Acoustical Core/Poly Jacket 25 Foot Long – R-4.2 – R-6 – R-8

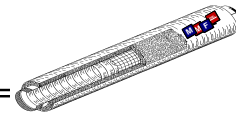

SIZE RD	LIST	R-4.2	R-4.2	LIST	R-6	R-6	LIST	R-8	R-8
	PRICE	PART	# PER	PRICE	PART	# PER	PRICE	PART	# PER
	25'L	NUMBER	CRTN.	25'L	NUMBER	CRTN.	25'L	NUMBER	CRTN.
4"	\$37.20	FDMAA2504	1	\$40.93	FDMAAR62504	1		FDMAAD2504	1
5"	\$38.82	FDMAA2505	1	\$42.62	FDMAAR62505	1		FDMAAD2505	1
6"	\$41.41	FDMAA2506	1	\$45.39	FDMAAR62506	1		FDMAAD2506	1
7"	\$46.83	FDMAA2507	1	\$51.23	FDMAAR62507	1		FDMAAD2507	1
8"	\$52.22	FDMAA2508	1	\$56.57	FDMAAR62508	1		FDMAAD2508	1
9"	\$63.63	FDMAA2509	1	\$68.34	FDMAAR62509	1		FDMAAD2509	1
10"	\$69.50	FDMAA2510	1	\$74.71	FDMAAR62510	1		FDMAAD2510	1
12"	\$81.66	FDMAA2512	1	\$87.18	FDMAAR62512	1		FDMAAD2512	1
14"	\$101.06	FDMAA2514	1	\$107.51	FDMAAR62514	1		FDMAAD2514	1
16"	\$118.61	FDMAA2516	1	\$125.47	FDMAAR62516	1		FDMAAD2516	1
18"	\$133.88	FDMAA2518	1	\$141.59	FDMAAR62518	1		FDMAAD2518	1
20"	\$155.84	FDMAA2520	1	\$165.94	FDMAAR62520			N/A	



**ACOUSTICAL /
WIRE HELIX CORE
FIBERGLASS
THREADED MESH
SCRIM
FIBERGLASS
INSULATION
DURABLE
POLYETHYLENE
JACKET**

Acoustical Core/Poly Jacket 6 Foot Long - R-4.2 - R-6 - R-8

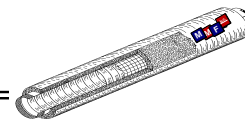

SIZE RD	LIST	R-4.2	R-4.2	LIST	R-6	R-6	LIST	R-8	R-8
	PRICE	PART	# PER	PRICE	PART	# PER	PRICE	PART	# PER
	6'L	NUMBER	CRTN.	6'L	NUMBER	CRTN.	6'L	NUMBER	CRTN.
4"	\$17.15	FDMAB0604	2	\$20.88	FDMABR60604	2		FDMABR80604	2
5"	\$20.08	FDMAB0605	2	\$23.88	FDMABR60605	2		FDMABR80605	2
6"	\$21.36	FDMAB0606	2	\$25.34	FDMABR60606	2		FDMABR80606	2
7"	\$23.70	FDMAB0607	2	\$27.68	FDMABR60607	2		FDMABR80607	2
8"	\$25.79	FDMAB0608	2	\$30.15	FDMABR60608	2		FDMABR80608	2
9"	\$28.99	FDMAB0609	2	\$33.70	FDMABR60609	2		FDMABR80609	2
10"	\$30.33	FDMAB0610	2	\$35.54	FDMABR60610	2		FDMABR80610	2
12"	\$36.98	FDMAB0612	2	\$42.49	FDMABR60612	2		FDMABR80612	2
14"	\$43.10	FDMAB0614	2	\$49.55	FDMABR60614	2		FDMABR80614	2
16"	\$53.25	FDMAB0616	2	\$60.25	FDMABR60616	2		FDMABR80616	2
18"	\$56.70	FDMAB0618	2	\$64.41	FDMABR60618	2		FDMABR80618	2
20"	\$65.52	FDMAB0620	2	\$76.22	N/A			N/A	



**** NOTICE **** Catalog pricing is based on # PER CRTN. Broken CRTN. quantity order, and may be subject to additional charge.

Multi: _____

7/1/09

r1/12/09

32AA-06



MODULAR METAL FABRICATORS INC.

Compressed Aluminum Flexible Air Duct Bare / Raw - 10' Lengths - UL Listed

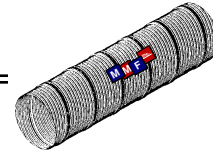

SIZE	PER CARTON	LIST PRICE PER LENGTH	PART NUMBER
3"	36 LENGTHS	\$9.67	MFCBR 1003
4"	21 LENGTHS	\$10.25	MFCBR 1004



**** NOTICE **** Packaged in multi piece carton. Broken carton may be subject to an additional charge.

Aluminum Flexible Air Duct - Bare

SIZE	LIST PRICE		LIST PRICE		LIST PRICE	
	RAW	PART NUMBER	COE	PART NUMBER	CBE	PART NUMBER
3" x 10'L	\$9.67	MFBR1003	\$12.41	MFBC1003	\$15.08	MFBD1003
4" x 10'L	\$10.25	MFBR1004	\$14.49	MFBC1004	\$17.13	MFBD1004
3" x 6'L	\$5.80	MFBR0603	\$7.88	MFBC0603	\$9.86	MFBD0603
4" x 6'L	\$7.02	MFBR0604	\$8.72	MFBC0604	\$10.28	MFBD0603
5" x 6'L	\$8.19	MFBR0605	\$10.55	MFBC0605	\$11.86	MFBD0605
6" x 6'L	\$9.91	MFBR0606	\$12.17	MFBC0606	\$13.13	MFBD0606
7" x 6'L	\$11.72	MFBR0607	\$13.99	MFBC0607	\$15.50	MFBD0607
8" x 6'L	\$12.71	MFBR0608	\$15.83	MFBC0608	\$17.11	MFBD0608
9" x 6'L	\$14.43	MFBR0609	\$17.66	MFBC0609	\$19.61	MFBD0609
10" x 6'L	\$16.46	MFBR0610	\$20.46	MFBC0610	\$21.63	MFBD0610
12" x 6'L	\$19.82	MFBR0612	\$23.58	MFBC0612	\$25.90	MFBD0612
14" x 6'L	\$22.94	MFBR0614	\$27.56	MFBC0614	\$30.26	MFBD0614
16" x 6'L	\$26.60	MFBR0616	\$32.53	MFBC0616	\$34.69	MFBD0616
18" x 6'L	\$32.32	MFBR0618	\$38.77	MFBC0618	\$40.93	MFBD0618

**RAW = RAW
ENDS**
**COE = COLLAR
ONE END**
**CBE = COLLAR
BOTH ENDS**

**FOR
LENGTHS
NOT
SHOWN
PLEASE
CALL FOR
PRICING.**

**BARE
LENGTHS
UP TO 10'
AVAILABLE
UPON
REQUEST.**

**** NOTICE ****
Catalog pricing is based on a "standard pack" quantity.
Non "standard pack" quantity orders may be subject to an additional charge.

Multi: _____

7/1/09

33A-04



MODULAR METAL FABRICATORS INC.

Aluminum Flexible Air Duct – R-4.2 – R-6 – R-8 6' Long-MFID Series-Fiberglass and *Black Jacket*

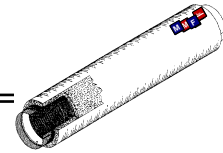

Size	R-4.2 List Price	R-4.2 Part Number	R-6 List Price	R-6 Part Number	R-8 List Price	R-8 Part Number
4"	\$14.67	MFID0604	\$16.72	MFID60604	\$20.03	MFID80604
5"	\$19.50	MFID0605	\$22.24	MFID60605	\$26.69	MFID80605
6"	\$21.19	MFID0606	\$24.13	MFID60606	\$28.97	MFID80606
7"	\$25.21	MFID0607	\$28.74	MFID60607	\$34.49	MFID80607
8"	\$26.67	MFID0608	\$30.40	MFID60608	\$36.48	MFID80608
9"	\$30.37	MFID0609	\$34.64	MFID60609	\$41.56	MFID80609
10"	\$33.40	MFID0610	\$38.08	MFID60610	\$45.71	MFID80610
12"	\$40.25	MFID0612	\$45.89	MFID60612	\$55.06	MFID80612
14"	\$44.27	MFID0614	\$50.49	MFID60614	\$60.58	MFID80614
16"	\$51.12	MFID0616	\$58.27	MFID60616	\$69.94	MFID80616
18"	\$61.10	MFID0618	\$69.67	MFID60618	\$83.58	MFID80618



**UL Listed
181 – Form B**

**Collar
Both Ends**

PRICE EFFECTIVE DATE: 02/13/2012

Aluminum Flexible Air Duct – R-4.2 – R-6 – R-8 6' Long-MFIDM Series-Fiberglass and *Silver Jacket*

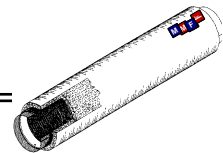

Size	R-4.2 List Price	R-4.2 Part Number	R-6 List Price	R-6 Part Number	R-8 List Price	R-8 Part Number
4"	\$15.60	MFIDM40604	\$17.18	MFIDM60604	\$20.63	MFIDM80604
5"	\$19.77	MFIDM40605	\$22.85	MFIDM60605	\$27.43	MFIDM80605
6"	\$21.85	MFIDM40606	\$24.79	MFIDM60606	\$29.75	MFIDM80606
7"	\$24.16	MFIDM40607	\$29.55	MFIDM60607	\$35.47	MFIDM80607
8"	\$26.40	MFIDM40608	\$31.24	MFIDM60608	\$37.46	MFIDM80608
9"	\$29.11	MFIDM40609	\$35.58	MFIDM60609	\$42.71	MFIDM80609
10"	\$33.02	MFIDM40610	\$39.12	MFIDM60610	\$46.96	MFIDM80610
12"	\$38.95	MFIDM40612	\$47.12	MFIDM60612	\$56.58	MFIDM80612
14"	\$44.47	MFIDM40614	\$51.85	MFIDM60614	\$62.21	MFIDM80614
16"	\$51.65	MFIDM40616	\$59.85	MFIDM60616	\$71.80	MFIDM80616
18"	\$58.51	MFIDM40618	\$71.53	MFIDM60618	\$85.84	MFIDM80618



**UL Listed
181 – Form B**

**Collar
Both Ends**

PRICE EFFECTIVE DATE: 02/13/2012

** NOTICE **

Catalog pricing is based on a "standard pack" quantity.
Non "standard pack" quantity orders may be subject to an additional charge

Multi _____

7/1/09

r2/13/12

33AA-04



MODULAR METAL FABRICATORS INC.

Black UV Nylon Duct Clamp

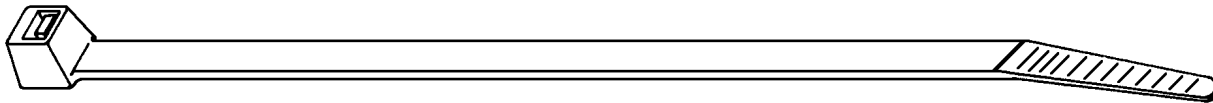

For clamping Flexible Air Ducts and securing other HVAC components.

- High Strength**
 Rated at 175-lb. minimum loop tensile strength. Designed to meet or exceed government designation Standards, where applicable. Actual test values exceed rated strength.
- Large Diameters**
 MDCV10-50 Clamp accommodates diameters up to 10".
 MDVC14-50 Clamp accommodates diameters up to 14".
 Clamps may be joined together for larger diameters.
- Clamping Flexible Duct (HVAC)**
 The larger sizes are for clamping connections, of flexible high or low-pressure HVAC duct, in heating and air conditioning applications. Secure, tightly clamped joints can be achieved easier and faster than with metal bands. Nylon clamps also cost less than metal bands and they eliminate the hazards of sharp metal edges. Nylon clamps may also be used to secure insulation to duct and to bundle cables.
- Material Specifications**
 All heavy-duty duct clamps are molded from Industrial Grade Type 6/6 black nylon. This nylon meets UL 94V-2 Flammability Classification. It's normal usage temperature range is -40° Fahrenheit (-40° Centigrade) to 185° Fahrenheit (85° Centigrade).

Duct Clamps are approved for clamping most types of flexible air ducts. These products meet or exceed U.L. 181 Class 1 standards. For indoor use only.

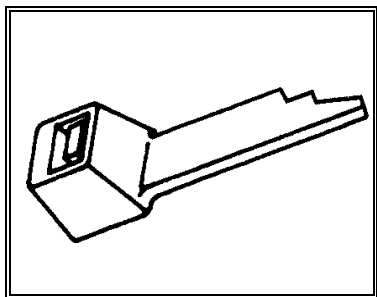

Self locking.
One piece design head.



EASY TO USE - One-piece, self locking, adjustable design, with no metal parts.

List price per bag. Bag quantity 50 each. Case quantity 500 each.

PART NUMBER	DUCT ID	TENSILE STRENGTH	OVERALL LENGTH	WIDTH	LIST PRICE
MDCV10-50	10"	175 lbs.	36"	0.345"	\$13.14
MDCV14-50	14"	175 lbs.	48"	0.345"	\$32.83
MDCVSTHV	Clamp Installation Tool				\$52.11

Multi: _____

4/1/10

r4/18/11

34A-14



MODULAR METAL FABRICATORS INC.

Hanger Strap - Galvanized Without and With Holes

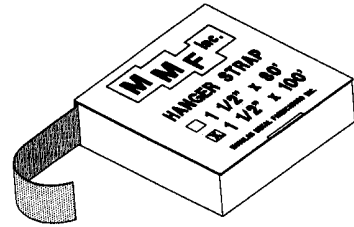

Without Holes	LIST	PART NUMBER	LIST	PART NUMBER	LIST	PART NUMBER
	PRICE		PRICE		PRICE	
SIZE	30 GA		26 GA		24 GA	
1 1/2" x 80' L	\$12.30	XXHSG01A80	\$13.97	XXHSI01A80	\$17.43	XXHSJ01A80
1 1/2" x 100L	\$13.03	XXHSG01A100	\$16.70	XXHSI01A100		NA

With Holes	LIST	PART NUMBER	LIST	PART NUMBER
	PRICE		PRICE	
SIZE	30 GA		26 GA	
1 1/2" x 80' L	\$12.30	XXHSXG01A80	\$13.97	XXHSXI01A80
1 1/2" x 100L	\$13.03	XXHSXG01A100	\$16.70	XXHSXI01A100

Standard Pack 250/Pallet

Plumbers Tape

SIZE	LIST	PART NUMBER
	PRICE	
	26 GA	
3/4" x 10'L	\$1.10	XXPTI3Q10

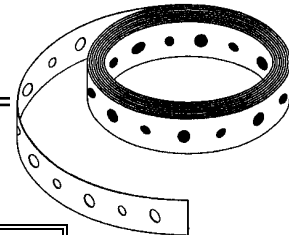

HOLES IN PLUMBERS
TAPE ALTERNATE
BETWEEN 3/16" AND
1/4" IN DIAMETER.

Standard Pack 100/Box

** NOTICE **

Catalog pricing is based on a "standard pack" quantity.
Non "standard pack" quantity orders may be subject to an additional charge.

Multi: _____

7/1/09

r5/1/10

35A-03



MODULAR METAL FABRICATORS INC.

Universal Connectors Flex Duct - Spiral Duct Assembled - 5" High Undersized Raw

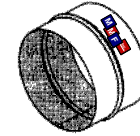

SIZE	LIST PRICE	PART NUMBER	LIST PRICE	PART NUMBER	LIST PRICE	PART NUMBER	LIST PRICE	PART NUMBER
	30 GA		28 GA		26 GA		24 GA	
4"	\$1.00	COUG0405RA	\$1.13	COUH0405RA	\$1.20	COUI0405RA	\$1.37	COUJ0405RA
5"	\$1.20	COUG0505RA	\$1.33	COUH0505RA	\$1.37	COUI0505RA	\$1.63	COUJ0505RA
6"	\$1.37	COUG0605RA	\$1.53	COUH0605RA	\$1.60	COUI0605RA	\$1.80	COUJ0605RA
7"	\$1.60	COUG0705RA	\$1.77	COUH0705RA	\$1.83	COUI0705RA	\$2.17	COUJ0705RA
8"	\$2.17	COUG0805RA	\$2.43	COUH0805RA	\$2.53	COUI0805RA	\$2.93	COUJ0805RA
9"	\$2.67	COUG0905RA	\$2.93	COUH0905RA	\$3.07	COUI0905RA	\$3.60	COUJ0905RA
10"	\$2.97	COUG1005RA	\$3.30	COUH1005RA	\$3.47	COUI1005RA	\$4.03	COUJ1005RA
12"	\$3.70	COUG1205RA	\$4.10	COUH1205RA	\$4.27	COUI1205RA	\$5.00	COUJ1205RA
14"	\$4.13	COUG1405RA	\$4.57	COUH1405RA	\$4.73	COUI1405RA	\$5.57	COUJ1405RA
16"	\$5.20	COUG1605RA	\$5.73	COUH1605RA	\$6.03	COUI1605RA	\$7.03	COUJ1605RA
18"	\$6.57	COUG1805RA	\$7.27	COUH1805RA	\$7.60	COUI1805RA	\$8.90	COUJ1805RA
20"	\$7.63	COUG2005RA	\$8.53	COUH2005RA	\$8.93	COUI2005RA	\$10.43	COUJ2005RA
22"	\$8.03	COUG2205RA	\$9.00	COUH2205RA	\$9.40	COUI2205RA	\$11.00	COUJ2205RA
24"	\$10.33	COUG2405RA	\$11.57	COUH2405RA	\$12.93	COUI2405RA	\$14.17	COUJ2405RA

Duct Connectors 4" High - Raw - Bead 5/8" up Each End Male / Female Locking Device - KD

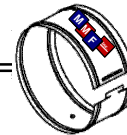

SIZE	LIST PRICE	PART NUMBER
4"	\$0.83	CODG0404BR
5"	\$0.97	CODG0504BR
6"	\$1.13	CODG0604BR
7"	\$1.27	CODG0704BR
8"	\$1.40	CODG0804BR
9"	\$1.57	CODG0904BR
10"	\$1.77	CODG1004BR
12"	\$2.07	CODG1204BR
14"	\$2.40	CODG1404BR
16"	\$2.67	CODG1604BR
18"	\$3.03	CODG1804BR
20"	\$3.33	CODG2004BR

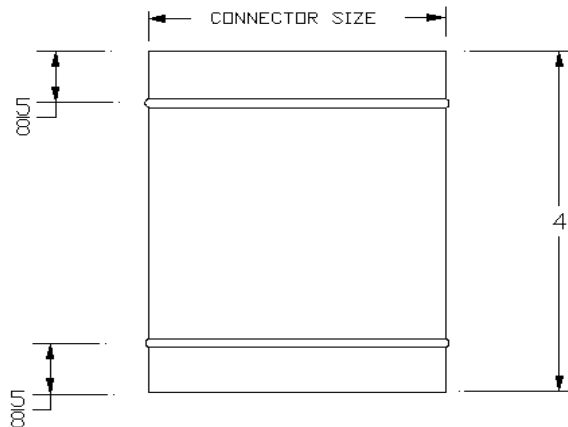

**** NOTICE ****
Catalog pricing is based on "standard pack" quantity.
Non "standard pack" quantity orders may be subject to an additional charge.

Multi: _____

7/1/09

r10/7/09

36A-03



MODULAR METAL FABRICATORS INC.

Start Collars 5" & 6" High- Crimp- Dove Tail

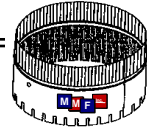

SIZE	LIST PRICE	<i>KD</i> PART	LIST PRICE	<i>KD</i> PART	LIST PRICE	<i>KD</i> PART
	30 GA 5"H	NUMBER	28 GA 6"H	NUMBER	26 GA 5"H	NUMBER
4"	\$1.08	COSGK04	\$1.20	COSHK04	\$1.32	COSIK04
5"	\$1.14	COSGK05	\$1.27	COSHK05	\$1.40	COSIK05
6"	\$1.17	COSGK06	\$1.30	COSHK06	\$1.65	COSIK06
7"	\$1.47	COSGK07	\$1.63	COSHK07	\$2.07	COSIK07
8"	\$1.56	COSGK08	\$1.73	COSHK08	\$2.20	COSIK08
9"	\$1.83	COSGK09	\$2.03	COSHK09	\$2.53	COSIK09
10"	\$2.10	COSGK10	\$2.33	COSHK10	\$2.56	COSIK10
12"	\$2.58	COSGK12	\$2.87	COSHK12	\$3.16	COSIK12
14"	\$2.82	COSGK14	\$3.13	COSHK14	\$3.44	COSIK14
16"	\$3.27	COSGK16	\$3.63	COSHK16	\$3.99	COSIK16
18"	\$4.02	COSGK18	\$4.47	COSHK18	\$4.92	COSIK18
20"	\$5.04	COSGK20	\$5.60	COSHK20	\$6.16	COSIK20
22"					\$9.93	COSIK22
24"					\$10.90	COSIK24
26"					\$15.60	COSIK26

30 , 28 & 26 GAUGE ARE KD

**ALL SIZES
25 PER BUNDLE**

NO BROKEN BUNDLES PLEASE

**** NOTICE **** Catalog pricing is based on a "standard pack" quantity
Non "standard pack" quantity may be subject to an additional charge.

Multi: _____

7/1/09

r6/1/07

37A-03



1" Duct Board Starting Collar
Bead - Dove Tail - KD

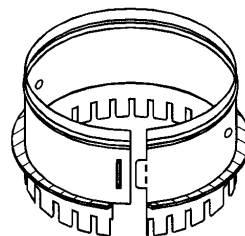

SIZE	LIST PRICE	PART NUMBER
4"	\$0.97	CODBH04S
5"	\$1.25	CODBH05S
6"	\$1.42	CODBH06S
7"	\$1.59	CODBH07S
8"	\$1.77	CODBH08S
9"	\$2.01	CODBH09S
10"	\$2.22	CODBH10S
12"	\$2.60	CODBH12S
14"	\$3.15	CODBH14S
16"	\$3.64	CODBH16S
18"	\$4.06	CODBH18S
20"	\$4.50	CODBH20S

STANDARD PACK
10 PER BUNDLE
NO BROKEN BUNDLES
PLEASE

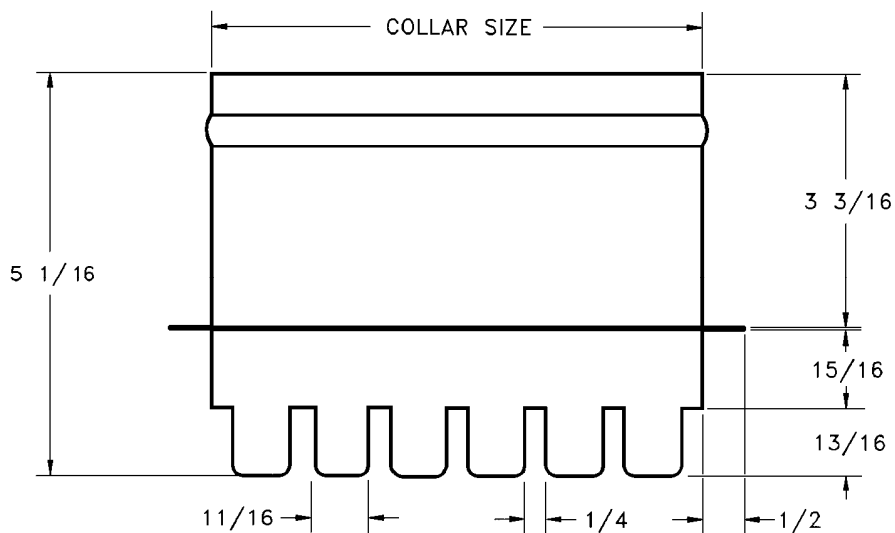

Side View

**** NOTICE ****
 Catalog pricing is based on a "standard pack" quantity.
 Non "standard pack" quantity orders may be subject to an additional charge.

Multi:

7/1/09

r5/1/10

38A-03



MODULAR METAL FABRICATORS INC.

SuperSeal Start Collars 26 Gauge - 6" High - With Peel and Stick Gasket *

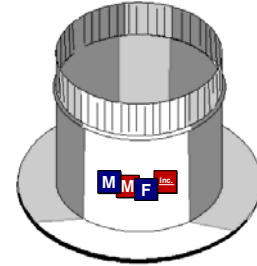

SIZE	LIST PRICE	PART NUMBER	LIST PRICE	PART NUMBER	LIST PRICE	PART NUMBER	LIST PRICE	PART NUMBER
	NO DAMPER		W/DAMPER		W/SCOOP		W/SCOOP & DAMPER	
4"	\$4.72	SI1SSCI04	\$9.40	SI1SSDI04	\$6.61	SI1SSEI04	\$11.27	SI1SSLI04
5"	\$4.86	SI1SSCI05	\$9.54	SI1SSDI05	\$6.82	SI1SSEI05	\$11.49	SI1SSLI05
6"	\$5.28	SI1SSCI06	\$10.36	SI1SSDI06	\$7.26	SI1SSEI06	\$12.34	SI1SSLI06
7"	\$5.95	SI1SSCI07	\$11.39	SI1SSDI07	\$8.07	SI1SSEI07	\$13.50	SI1SSLI07
8"	\$6.51	SI1SSCI08	\$12.12	SI1SSDI08	\$8.76	SI1SSEI08	\$14.38	SI1SSLI08
9"	\$7.72	SI1SSCI09	\$13.50	SI1SSDI09	\$10.16	SI1SSEI09	\$15.91	SI1SSLI09
10"	\$8.42	SI1SSCI10	\$14.39	SI1SSDI10	\$11.14	SI1SSEI10	\$17.13	SI1SSLI10
12"	\$9.93	SI1SSCI12	\$16.64	SI1SSDI12	\$12.88	SI1SSEI12	\$19.56	SI1SSLI12
14"	\$11.39	SI1SSCI14	\$18.85	SI1SSDI14	\$14.59	SI1SSEI14	\$22.05	SI1SSLI14
16"	\$14.23	SI1SSCI16	\$22.81	SI1SSDI16	\$18.16	SI1SSEI16	\$26.74	SI1SSLI16
18"	\$19.94	SI1SSCI18	\$29.61	SI1SSDI18	\$24.15	SI1SSEI18	\$33.83	SI1SSLI18
20"	\$21.59	SI1SSCI20	\$32.74	SI1SSDI20	\$26.41	SI1SSEI20	\$37.55	SI1SSLI20

WITH DAMPER

4" THRU 20"

INCLUDES:

- 2 - BEARINGS
- 1 - HANDLE
- 2 - WASHERS
- 2 - WING NUTS

* ADVISORY: When installing product, the gasket sealing ring must be secured with the appropriate fasteners.

*Apply sealant when/where necessary.

**** NOTICE ****

Catalog pricing is based on "standard pack" quantity.
Non "standard pack" quantity orders may be subject to an additional charge.

Multi _____

7/1/09

R4/1/10

38AA-10



MODULAR METAL FABRICATORS INC.

Curbs - See page 20C-03 for Cooler Flashings

Modular Metal Fabricators, Inc. manufactures high quality curbs per your customers specifications. Please call for pricing.

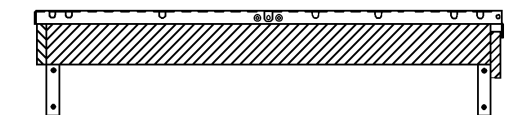
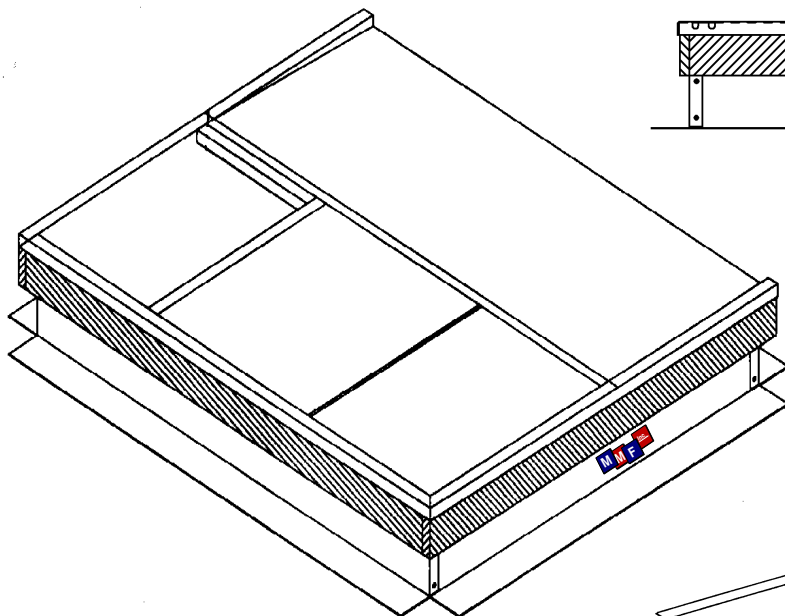

ADVISORY: When installing product, Apply Sealant when/where necessary.

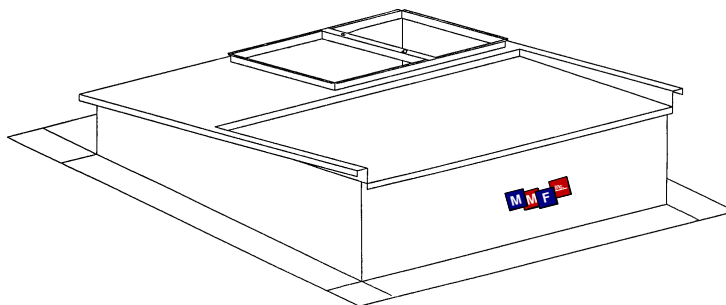
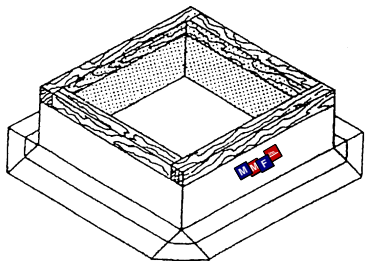
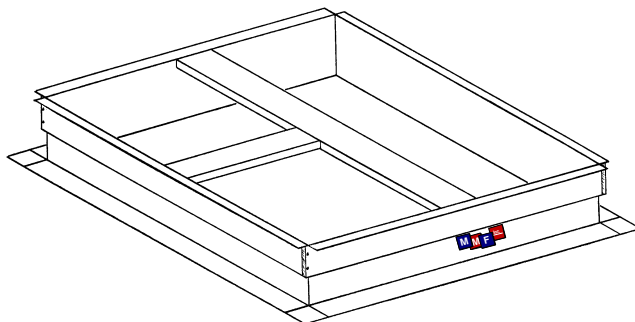
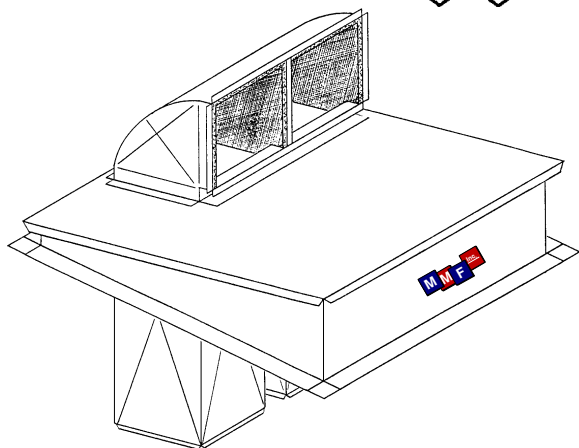

Multi: _____

7/1/09

39A-00



MODULAR METAL FABRICATORS INC.

Damper Disc - No Hardware

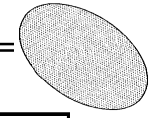

SIZE	LIST PRICE 30 GA	PART NUMBER	LIST PRICE 28 GA	PART NUMBER	LIST PRICE 26 GA	PART NUMBER	LIST PRICE 24 GA	PART NUMBER
4"	\$0.90	DMDG04	\$1.00	DMDH04	\$1.03	DMDI04	\$1.23	DMDJ04
5"	\$1.13	DMDG05	\$1.27	DMDH05	\$1.33	DMDI05	\$1.53	DMDJ05
6"	\$1.33	DMDG06	\$1.50	DMDH06	\$1.57	DMDI06	\$1.83	DMDJ06
7"	\$1.37	DMDG07	\$1.53	DMDH07	\$1.60	DMDI07	\$1.87	DMDJ07
8"	\$1.63	DMDG08	\$1.83	DMDH08	\$1.90	DMDI08	\$2.23	DMDJ08
9"	\$1.83	DMDG09	\$2.07	DMDH09	\$2.17	DMDI09	\$2.53	DMDJ09
10"	\$2.20	DMDG10	\$2.47	DMDH10	\$2.60	DMDI10	\$3.00	DMDJ10
12"	\$2.33	DMDG12	\$2.63	DMDH12	\$2.93	DMDI12	\$3.40	DMDJ12
14"			\$2.83	DMDH14	\$3.13	DMDI14	\$3.70	DMDJ14
16"			\$3.97	DMDH16	\$4.40	DMDI16	\$5.13	DMDJ16
18"			\$5.33	DMDH18	\$5.90	DMDI18	\$6.43	DMDJ18
20"					\$7.63	DMDI20	\$9.23	DMDJ20
22"					\$9.77	DMDI22	\$11.83	DMDJ22
24"					\$12.93	DMDI24	\$15.67	DMDJ24
26"							\$16.07	DMDJ26

Damper Disc - With Hardware

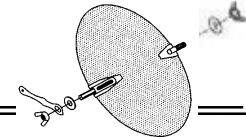

SIZE	LIST PRICE 30 GA	PART NUMBER	LIST PRICE 28 GA	PART NUMBER	LIST PRICE 26 GA	PART NUMBER	LIST PRICE 24 GA	PART NUMBER
4"	\$3.53	DMHG04	\$3.93	DMHH04	\$4.13	DMHI04	\$4.83	DMHJ04
5"	\$3.73	DMHG05	\$4.17	DMHH05	\$4.33	DMHI05	\$5.10	DMHJ05
6"	\$4.07	DMHG06	\$4.57	DMHH06	\$4.77	DMHI06	\$5.57	DMHJ06
7"	\$4.40	DMHG07	\$4.90	DMHH07	\$5.13	DMHI07	\$6.03	DMHJ07
8"	\$4.60	DMHG08	\$5.17	DMHH08	\$5.40	DMHI08	\$6.33	DMHJ08
9"	\$4.97	DMHG09	\$5.53	DMHH09	\$5.80	DMHI09	\$6.80	DMHJ09
10"	\$5.27	DMHG10	\$5.93	DMHH10	\$6.17	DMHI10	\$7.23	DMHJ10
12"	\$7.67	DMHG12	\$8.53	DMHH12	\$8.97	DMHI12	\$10.53	DMHJ12
14"			\$9.17	DMHH14	\$10.17	DMHI14	\$11.83	DMHJ14
16"			\$11.47	DMHH16	\$12.73	DMHI16	\$14.80	DMHJ16
18"			\$13.63	DMHH18	\$15.13	DMHI18	\$17.60	DMHJ18
20"					\$16.77	DMHI20	\$20.30	DMHJ20
22"					\$19.90	DMHI22	\$24.07	DMHJ22
24"					\$23.77	DMHI24	\$28.77	DMHJ24
26"							\$31.40	DMHJ26

**4" THRU 26"
INCLUDES:
2 - BEARINGS
1 - HANDLE
2 - WASHERS
2 - WING NUTS**

Dampers with hardware only :
Standard Packaging
Quantities
4" through 20"
25 per box

**** NOTICE **** Catalog pricing is based on a "standard pack" quantity.
Non "standard pack" quantity orders may be subject to an additional charge.

Multi: _____

7/1/09

r5/1/10

40A-03



MODULAR METAL FABRICATORS INC.

Galvanized Metal Sheets

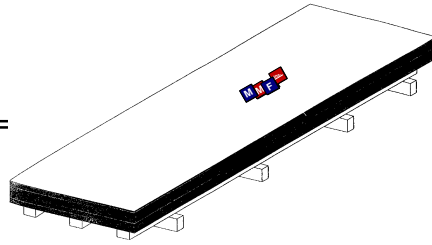

GAUGE	WIDTH	LENGTH	LIST PRICE	PART NUMBER
30	36	120	C	MSSG36120
30	36	96	A	MSSG3696
28	36	120	L	MSSH36120
28	36	96	L	MSSH3696
28	48	120		MSSH48120
28	48	96		MSSH4896
26	36	120	F	MSSI36120
26	36	96	O	MSSI3696
26	48	120	R	MSSI48120
26	48	96		MSSI4896
24	36	120		MSSJ36120
24	36	96	P	MSSJ3696
24	48	120	R	MSSJ48120
24	48	96	I	MSSJ4896
22	36	120	C	MSSK36120
22	36	96	I	MSSK3696
22	48	120	N	MSSK48120
22	48	96	G	MSSK4896

**PALLET DEPOSIT
CHARGE OF \$25.00 NET.
CREDIT ISSUED UPON
RETURN.**

Galvanized Hardware Cloth - 1/4" sizes

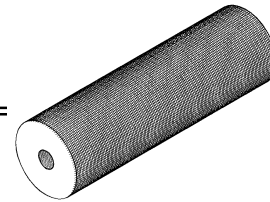

SIZE	LIST PRICE	PART NUMBER
1/4"	\$178.84	XXHCQ36100

**HARDWARE CLOTH IS
SOLD IN ROLLS 36" WIDE
X 100' LONG**

**** NOTICE ****
Catalog pricing is based on a "standard pack" quantity.
Non "standard pack" quantity orders may be subject to an additional charge.

Multi: _____

7/1/09

r7/19/11

41A-07



MODULAR METAL FABRICATORS INC.

Specifications for Sheet Metal Spin-ins

Low pressure sheet metal fittings used for round take offs from rectangular ducts. A fast positive installation that is available in a wide range of types and sizes.

Extractor is factory installed. Damper is spring loaded with retractable bearing and locking regulator. Construction is prime galvanized steel. All fittings are Union made and labeled. Fiberglass guard available on request.

We do not recommend that holes be cut in duct until you have your Spin-ins, or call MMF, inc. for hole size. Call for sizes and gauges not shown.

Sheet Metal Spin-ins - One Series

SIZE	GAUGE	LIST	PART	LIST	PART	LIST	PART	LIST	PART
		PRICE		SM-1C		PRICE		SM-1D	
4"	28	\$2.83	SI1SCH04	\$6.00	SI1SDH04	\$4.97	SI1SEH04	\$8.13	SI1SLH04
5"	28	\$3.07	SI1SCH05	\$6.43	SI1SDH05	\$5.43	SI1SEH05	\$8.80	SI1SLH05
6"	28	\$3.17	SI1SCH06	\$6.83	SI1SDH06	\$5.73	SI1SEH06	\$9.67	SI1SLH06
7"	28	\$4.13	SI1SCH07	\$7.87	SI1SDH07	\$6.47	SI1SEH07	\$10.13	SI1SLH07
8"	28	\$5.13	SI1SCH08	\$9.07	SI1SDH08	\$8.13	SI1SEH08	\$12.37	SI1SLH08
9"	28	\$7.00	SI1SCH09	\$11.17	SI1SDH09	\$10.50	SI1SEH09	\$14.73	SI1SLH09
10"	28	\$7.83	SI1SCH10	\$12.47	SI1SDH10	\$11.97	SI1SEH10	\$16.67	SI1SLH10
12"	26	\$9.60	SI1SCI12	\$15.53	SI1SDI12	\$14.50	SI1SEI12	\$20.47	SI1SLI12
14"	26	\$11.63	SI1SCI14	\$18.97	SI1SDI14	\$17.37	SI1SEI14	\$24.57	SI1SLI14
16"	26	\$14.83	SI1SCI16	\$23.40	SI1SDI16	\$21.93	SI1SEI16	\$30.47	SI1SLI16
18"	24	\$18.30	SI1SCJ18	\$29.13	SI1SDJ18	\$27.90	SI1SEJ18	\$37.50	SI1SLJ18

Sheet Metal Spin-ins - Two Series/Conical

SIZE	GAUGE	LIST	PART	LIST	PART	LIST	PART	LIST	PART
		PRICE		SM-2C		PRICE		SM-2D	
4"	28	\$7.30	SI2SCH04	\$10.47	SI2SDH04	\$9.53	SI2SEH04	\$12.70	SI2SLH04
5"	28	\$7.50	SI2SCH05	\$10.83	SI2SDH05	\$10.07	SI2SEH05	\$13.50	SI2SLH05
6"	28	\$8.00	SI2SCH06	\$11.77	SI2SDH06	\$10.63	SI2SEH06	\$14.37	SI2SLH06
7"	28	\$10.33	SI2SCH07	\$14.10	SI2SDH07	\$13.00	SI2SEH07	\$16.83	SI2SLH07
8"	28	\$12.87	SI2SCH08	\$16.33	SI2SDH08	\$15.30	SI2SEH08	\$19.40	SI2SLH08
9"	28	\$16.30	SI2SCH09	\$20.37	SI2SDH09	\$19.83	SI2SEH09	\$23.97	SI2SLH09
10"	28	\$18.57	SI2SCH10	\$23.43	SI2SDH10	\$22.87	SI2SEH10	\$27.80	SI2SLH10
12"	26	\$21.13	SI2SCI12	\$26.73	SI2SDI12	\$26.17	SI2SEI12	\$31.73	SI2SLI12
14"	26	\$25.00	SI2SCI14	\$32.50	SI2SDI14	\$30.87	SI2SEI14	\$38.40	SI2SLI14
16"	26	\$31.43	SI2SCI16	\$40.17	SI2SDI16	\$35.97	SI2SEI16	\$47.47	SI2SLI16
18"	24	\$41.47	SI2SCJ18	\$53.00	SI2SDJ18	\$41.07	SI2SEJ18	\$62.60	SI2SLJ18

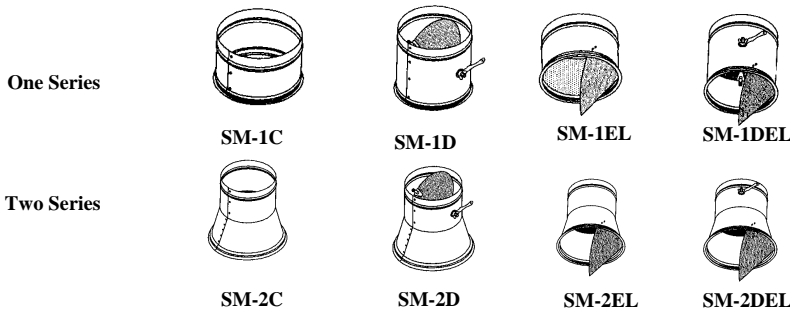

Multi: _____

7/1/09

R5/1/10

1B-10



MODULAR METAL FABRICATORS INC.

SuperSeal Start Collars 26 Gauge - 6" High - With Peel and Stick Gasket *

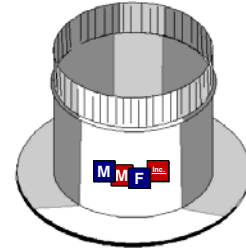

SIZE	LIST PRICE	PART NUMBER	LIST PRICE	PART NUMBER	LIST PRICE	PART NUMBER	LIST PRICE	PART NUMBER
	NO DAMPER		W/DAMPER		W/SCOOP		W/SCOOP & DAMPER	
4"	\$4.72	SI1SSCI04	\$9.40	SI1SSDI04	\$6.61	SI1SSEI04	\$11.27	SI1SSLI04
5"	\$4.86	SI1SSCI05	\$9.54	SI1SSDI05	\$6.82	SI1SSEI05	\$11.49	SI1SSLI05
6"	\$5.28	SI1SSCI06	\$10.36	SI1SSDI06	\$7.26	SI1SSEI06	\$12.34	SI1SSLI06
7"	\$5.95	SI1SSCI07	\$11.39	SI1SSDI07	\$8.07	SI1SSEI07	\$13.50	SI1SSLI07
8"	\$6.51	SI1SSCI08	\$12.12	SI1SSDI08	\$8.76	SI1SSEI08	\$14.38	SI1SSLI08
9"	\$7.72	SI1SSCI09	\$13.50	SI1SSDI09	\$10.16	SI1SSEI09	\$15.91	SI1SSLI09
10"	\$8.42	SI1SSCI10	\$14.39	SI1SSDI10	\$11.14	SI1SSEI10	\$17.13	SI1SSLI10
12"	\$9.93	SI1SSCI12	\$16.64	SI1SSDI12	\$12.88	SI1SSEI12	\$19.56	SI1SSLI12
14"	\$11.39	SI1SSCI14	\$18.85	SI1SSDI14	\$14.59	SI1SSEI14	\$22.05	SI1SSLI14
16"	\$14.23	SI1SSCI16	\$22.81	SI1SSDI16	\$18.16	SI1SSEI16	\$26.74	SI1SSLI16
18"	\$19.94	SI1SSCI18	\$29.61	SI1SSDI18	\$24.15	SI1SSEI18	\$33.83	SI1SSLI18
20"	\$21.59	SI1SSCI20	\$32.74	SI1SSDI20	\$26.41	SI1SSEI20	\$37.55	SI1SSLI20

WITH DAMPER

4" THRU 20"

INCLUDES:

- 2 - BEARINGS
- 1 - HANDLE
- 2 - WASHERS
- 2 - WING NUTS

* ADVISORY: When installing product, the gasket sealing ring must be secured with the appropriate fasteners.

*Apply sealant when/where necessary.

**** NOTICE ****

Catalog pricing is based on "standard pack" quantity.
Non "standard pack" quantity orders may be subject to an additional charge.

Multi _____

7/1/09

R5/1/10

1BB-10

Sheet Metal Spin-in Specifications

SM 1 SERIES

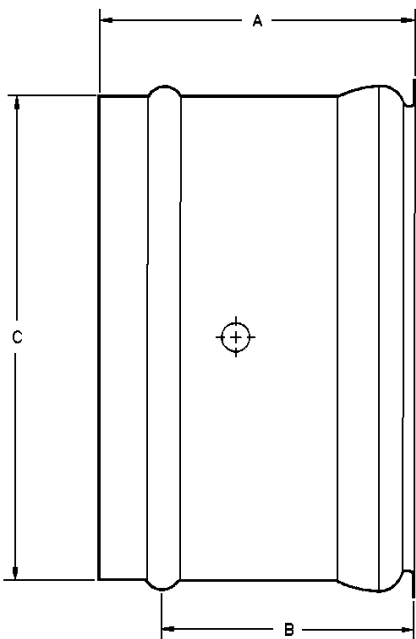
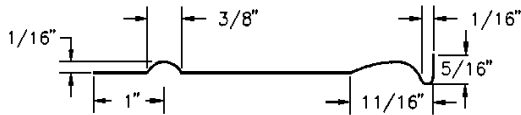

SM - 1C				SM - 1D			
SIZE	A	B	C	SIZE	A	B	C
4"	3 3/4"	2 3/4"	3 3/4"	4"	5 3/4"	4 3/4"	3 3/4"
5"	3 3/4"	2 3/4"	4 3/4"	5"	5 3/4"	4 3/4"	4 3/4"
6"	3 3/4"	2 3/4"	5 3/4"	6"	5 3/4"	4 3/4"	5 3/4"
7"	3 3/4"	2 3/4"	6 3/4"	7"	8 3/4"	6 3/4"	6 3/4"
8"	3 3/4"	2 3/4"	7 3/4"	8"	8 3/4"	6 3/4"	7 3/4"
9"	3 3/4"	2 3/4"	8 3/4"	9"	8 3/4"	6 3/4"	8 3/4"
10"	5 3/4"	4 3/4"	9 3/4"	10"	8 3/4"	6 3/4"	9 3/4"
12"	5 3/4"	4 3/4"	11 3/4"	12"	11 3/4"	8 3/4"	11 3/4"
14"	5 3/4"	4 3/4"	13 3/4"	14"	11 3/4"	8 3/4"	13 3/4"
16"	5 3/4"	4 3/4"	15 3/4"	16"	11 3/4"	10 3/4"	15 3/4"
18"	5 3/4"	4 3/4"	17 3/4"	18"	11 3/4"	10 3/4"	17 3/4"

NOTE: SEE SM2 DIMENSION CHART FOR EXTRACTOR LENGTHS OF SM1's →

SM 2 SERIES

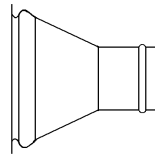

SM-2C

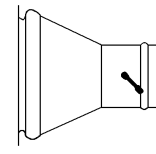

SM-2D

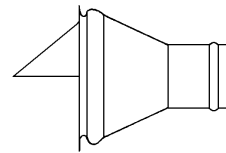

SM-2EL

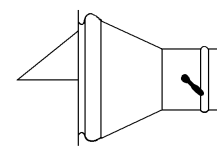

SM-2DEL

DIMENSIONS

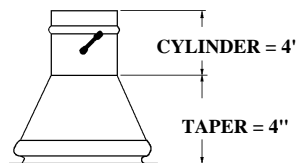

SM2 SERIES 4" - 9"

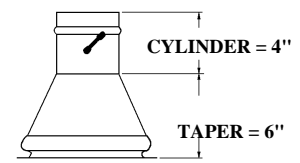

SM2 SERIES 10" - 18"

PIPE SIZE	APPROX. TAPER HOLE SIZE	CYLINDER HEIGHT	TAPER HEIGHT	LENGTH OF EXTRACTOR
4"	6"	4"	4"	1 1/2"
5"	7"	4"	4"	2 1/8"
6"	8"	4"	4"	2 5/8"
7"	9"	4"	4"	3 7/16"
8"	10"	4"	4"	3 3/4"
9"	11"	4"	4"	4 3/8"
10"	13"	4"	6"	4 9/16"
12"	15"	4"	6"	5 3/8"
14"	17"	4"	6"	6 1/4"
16"	19"	4"	6"	7 1/8"
18"	21"	4"	6"	8"

Multi: _____

7/1/09

1B-SPECS



MODULAR METAL FABRICATORS INC.

Specifications for Duct Board Spin-ins

Low pressure sheet metal fittings used for round take offs from square or rectangular ducts. A fast positive installation that is available in a wide range of types and sizes.

Extractor is factory installed. Damper is spring loaded with retractable bearing and locking regulator. Construction is prime galvanized steel. All fittings are Union made and labeled. Fiberglass guard available on request. We do not recommend that holes be cut in duct until you have your Spin-ins, or call MMF, inc. for hole size. Call for sizes and gauges not shown.

Duct Board Spin-ins - One Series

SIZE	GAUGE	LIST		LIST		LIST		LIST	
		PRICE	PART	PRICE	PART	PRICE	PART	PRICE	PART
		DB-1C	NUMBER	DB-1D	NUMBER	DB-1EL	NUMBER	DB-1DEL	NUMBER
4"	28	\$5.27	SI1DCH04	\$8.53	SI1DDH04	\$7.47	SI1DEH04	\$10.70	SI1DLH04
5"	28	\$5.97	SI1DCH05	\$5.97	SI1DDH05	\$5.97	SI1DEH05	\$5.97	SI1DLH05
6"	28	\$6.27	SI1DCH06	\$6.27	SI1DDH06	\$6.27	SI1DEH06	\$6.27	SI1DLH06
7"	28	\$7.97	SI1DCH07	\$7.97	SI1DDH07	\$7.97	SI1DEH07	\$7.97	SI1DLH07
8"	28	\$9.93	SI1DCH08	\$9.93	SI1DDH08	\$9.93	SI1DEH08	\$9.93	SI1DLH08
9"	28	\$13.40	SI1DCH09	\$13.40	SI1DDH09	\$13.40	SI1DEH09	\$13.40	SI1DLH09
10"	28	\$14.83	SI1DCH10	\$14.83	SI1DDH10	\$14.83	SI1DEH10	\$14.83	SI1DLH10
12"	26	\$16.67	SI1DCI12	\$16.67	SI1DDI12	\$16.67	SI1DEI12	\$16.67	SI1DLI12
14"	26	\$19.97	SI1DCI14	\$19.97	SI1DDI14	\$19.97	SI1DEI14	\$19.97	SI1DLI14
16"	26	\$22.77	SI1DCI16	\$22.77	SI1DDI16	\$22.77	SI1DEI16	\$22.77	SI1DLI16
18"	24	\$27.63	SI1DCJ18	\$27.63	SI1DDJ18	\$27.63	SI1DEJ18	\$27.63	SI1DLJ18

Duct Board Spin-ins - Two Series/Conical

SIZE	GAUGE	LIST		LIST		LIST		LIST	
		PRICE	PART	PRICE	PART	PRICE	PART	PRICE	PART
		DB-2C	NUMBER	DB-2D	NUMBER	DB-2EL	NUMBER	DB-2DEL	NUMBER
4"	28	\$12.17	SI2DCH04	\$15.30	SI2DDH04	\$14.27	SI2DEH04	\$17.53	SI2DLH04
5"	28	\$13.60	SI2DCH05	\$13.60	SI2DDH05	\$13.60	SI2DEH05	\$13.60	SI2DLH05
6"	28	\$14.40	SI2DCH06	\$14.40	SI2DDH06	\$14.40	SI2DEH06	\$14.40	SI2DLH06
7"	28	\$17.53	SI2DCH07	\$17.53	SI2DDH07	\$17.53	SI2DEH07	\$17.53	SI2DLH07
8"	28	\$22.00	SI2DCH08	\$22.00	SI2DDH08	\$22.00	SI2DEH08	\$22.00	SI2DLH08
9"	28	\$25.33	SI2DCH09	\$25.33	SI2DDH09	\$25.33	SI2DEH09	\$25.33	SI2DLH09
10"	28	\$28.23	SI2DCH10	\$28.23	SI2DDH10	\$28.23	SI2DEH10	\$28.23	SI2DLH10
12"	26	\$33.53	SI2DCI12	\$33.53	SI2DDI12	\$33.53	SI2DEI12	\$33.53	SI2DLI12
14"	26	\$39.93	SI2DCI14	\$39.93	SI2DDI14	\$39.93	SI2DEI14	\$39.93	SI2DLI14
16"	26	\$46.50	SI2DCI16	\$46.50	SI2DDI16	\$46.50	SI2DEI16	\$46.50	SI2DLI16
18"	24	\$53.07	SI2DCJ18	\$53.07	SI2DDJ18	\$53.07	SI2DEJ18	\$53.07	SI2DLJ18

ONE SERIES

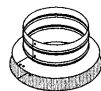

DB-1C

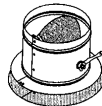

DB-1D



DB-1EL

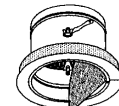

DB-1DEL

TWO SERIES

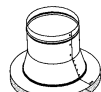

DB-2C



DB-2D



DB-2EL



DB-2DEL

Multi: _____

7/1/09

R5/1/10

2B-10



MODULAR METAL FABRICATORS INC.

Square to Square Transitions Bare - Raw - 2" High Body

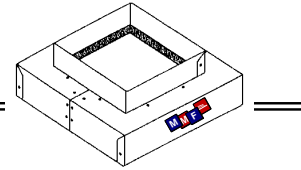

SIZE	LIST PRICE
22 x 22 to 6 x 6	\$28.70
22 x 22 to 8 x 8	\$30.00
22 x 22 to 10 x 10	\$31.97
22 x 22 to 12 x 12	\$34.13
22 x 22 to 14 x 14	\$44.30
22 x 22 to 16 x 16	\$38.00
22 x 22 to 18 x 18	\$39.97
22 x 22 to 20 x 20	\$41.70
24 x 24 to 6 x 6	\$29.37
24 x 24 to 8 x 8	\$31.97
24 x 24 to 10 x 10	\$34.00
24 x 24 to 12 x 12	\$36.00
24 x 24 to 14 x 14	\$38.00
24 x 24 to 16 x 16	\$39.97
24 x 24 to 18 x 18	\$43.10
24 x 24 to 20 x 20	\$43.63
24 x 24 to 22 x 22	\$46.00

For All Sizes Not Shown:

Gauge	List Price Per Girth Inch
28	\$0.33
26	\$0.37
24	\$0.47

Round Neck Adapters Bare - Raw - 3" High Body

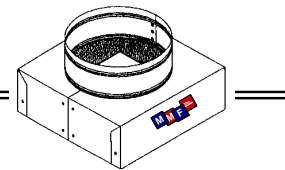

LENGTH	WIDTH	COLLAR	GAUGE	LIST PRICE
				1 THRU 24
6	6	4 THRU 6	28	\$8.13
7	7	4 THRU 7	28	\$8.83
8	8	4 THRU 8	28	\$9.50
9	9	4 THRU 9	28	\$10.10
10	10	6 THRU 10	28	\$10.57
12	12	6 THRU 12	28	\$12.00
14	14	6 THRU 14	28	\$13.60
15	15	6 THRU 14	28	\$13.87
16	16	6 THRU 16	28	\$15.17
18	18	6 THRU 18	28	\$16.47
20	20	6 THRU 20	26	\$23.57
22	10	6 THRU 22	26	\$18.93
22	22	6 THRU 22	26	\$25.13
23 1/2	11 1/2	6 THRU 10	26	\$20.90
23 1/2	23 1/2	6 THRU 22	26	\$26.43
24	12	6 THRU 12	26	\$24.57
24	24	6 THRU 18	26	\$29.67
24	24	20 THRU 24	26	\$31.57

For All Sizes Not Shown:

Gauge	List Price Per Girth Inch
28	\$0.33
26	\$0.37
24	\$0.47

Call for Quote
For Painted Adapters

**** NOTICE **** Catalog pricing is based on a "standard pack" quantity.
Non "standard pack" quantity orders may be subject to and additional charge.

Multi: _____

7/1/09

r5/1/10

3B-10



MODULAR METAL FABRICATORS INC.

Perforated Diffusers

Molded Fiberglass Back 4"-16" RD

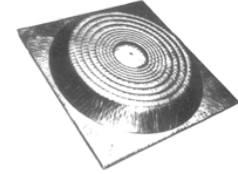

4 DEFLECTORS IN ALL 24 x 24 SUPPLIES.

1 REMOVE-ABLE 6" ROUND DISC IN UNIVERSAL (SUPPLY OR RETURN.)

SIZE	TYPE	# PER CARTON	LIST PRICE	PART NUMBER
24 x 24	RETURN	4	\$24.69	PDR2424
24 x 24	UNIVERSAL	4	\$25.49	PDU2424
24 x 24	SUPPLY	4	\$28.80	PDS2424
NOTE	FILTER GRILL	3"	STEEL	FRAME

Perforated Diffusers

Steel Frame 3" High with Fiberglass Back

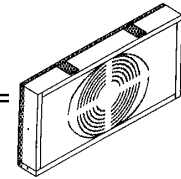

SIZE	RD.	TYPE	# PER CARTON	LIST PRICE	PART NUMBER
12 x 24	4 ~ 12	RETURN	6	\$20.10	PDRMD1224
24 x 24	4 ~ 20	RETURN	3	\$29.71	PDRMD2424
12 x 24	4 ~ 12	UNIVERSAL	6	\$20.47	PDUMD1224
24 x 24	4 ~ 20	UNIVERSAL	3	\$31.19	PDUMD2424
24 x 24	4 ~ 20	SUPPLY	3	\$32.71	PD SMD2424
24 x 24	4 ~ 20	FILTER GRILL	3	\$43.62	PD FMD2424

Perforated Diffusers - Steel Frame 3" High with Steel Back - Price Reflects Collar Installed

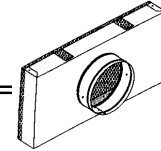

SIZE	RD.	TYPE	LIST PRICE	PART NUMBER
12 x 24	4 ~ 12	RETURN	\$29.63	PDRMM1224
24 x 24	4 ~ 20	RETURN	\$37.47	PDRMM2424
12 x 24	4 ~ 12	UNIVERSAL	\$29.97	PDUMM1224
24 x 24	4 ~ 20	UNIVERSAL	\$37.87	PDUMM2424
24 x 24	4 ~ 20	SUPPLY	\$40.60	PDSMM2424
24 x 24	4 ~ 20	FILTER GRILL	\$52.63	PDFMM2424

FILTERS FOR FILTER GRILLS ARE NOT SUPPLIED / MANUFACTURED BY MODULAR METALS.

CALL FOR INSTALLATION OF START COLLARS IN MOLDED BACK AND STEEL BACK WITH FG.

CARTON QUANTITY ARE SUBJECT TO CHANGE WHEN COLLARS ARE FACTORY INSTALLED IN DIFFUSERS.

Face / Grill Only

No Discounts		# PER CARTON	LIST PRICE	PART NUMBER
SIZE	TYPE			
12 x 24	PERFORATED FACE ONLY	64	\$9.63	PDG1224
24 x 24	PERFORATED FACE ONLY	24	\$14.10	PDG2424

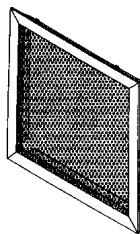

FILTER GRILL (PDF)

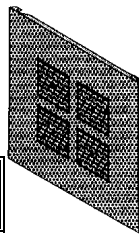

SUPPLY (PDS)

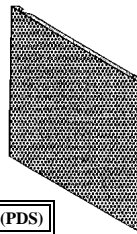

RETURN (PDR)



UNIVERSAL (PDU)

Multi: _____

7/1/09

r9/13/11

4B-14



Cushion Heads - Side

Outlet

Quoted on per job basis.

28 gauge - 22 gauge - 16 gauge earthquake straps. Bare - 1/2" liner - 1" liner

Standard Height is 3" over round collar.

Liner held up 2" from raw end.

Perforated Baffle available.

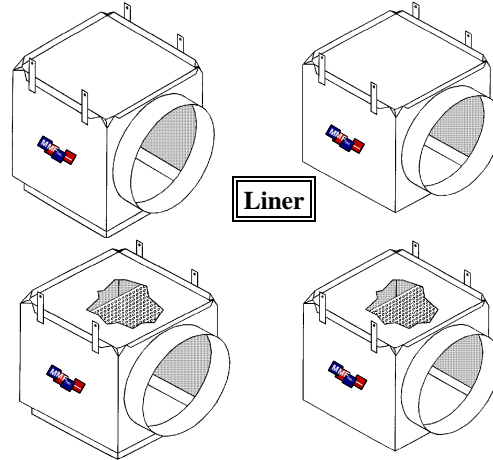

Liner

Liner - Perforated Baffle

Pancake Tapers "Cookie Cutters" - 5 1/2" High

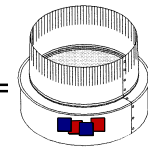

SIZE			LIST PRICE	PART NUMBER	LIST PRICE	PART NUMBER	LIST PRICE	PART NUMBER	LIST PRICE	PART NUMBER
			30 GA		28 GA		26 GA		24 GA	
5	to	3 ~ 5	\$5.93	TPPG05	\$6.66	TPPH05	\$6.97	TPPI05	\$8.14	TPPJ05
6	to	3 ~ 5	\$6.34	TPPG06	\$7.10	TPPH06	\$7.42	TPPI06	\$8.70	TPPJ06
7	to	4 ~ 6	\$6.97	TPPG07	\$7.77	TPPH07	\$8.11	TPPI07	\$9.50	TPPJ07
8	to	4 ~ 7	\$7.25	TPPG08	\$8.11	TPPH08	\$8.50	TPPI08	\$9.95	TPPJ08
9	to	4 ~ 8	\$7.70	TPPG09	\$8.60	TPPH09	\$8.98	TPPI09	\$10.54	TPPJ09
10	to	4 ~ 9	\$8.11	TPPG10	\$9.08	TPPH10	\$9.50	TPPI10	\$11.13	TPPJ10
12	to	8 ~ 10	\$12.06	TPPG12	\$13.49	TPPH12	\$14.11	TPPI12	\$16.50	TPPJ12
14	to	8 ~ 12	\$13.80	TPPG14	\$15.46	TPPH14	\$16.15	TPPI14	\$18.90	TPPJ14
16	to	10 ~ 14	\$16.12	TPPG16	\$18.10	TPPH16	\$18.86	TPPI16	\$22.12	TPPJ16
18	to	10 ~ 16	\$18.82	TPPG18	\$21.11	TPPH18	\$22.05	TPPI18	\$25.79	TPPJ18

STANDARD WITH CRIMP SMALL END. FOR 6" HIGH -- OR 8" HIGH - CALL FOR QUOTE

ALSO AVAILABLE IN NOMINAL/NO CRIMP BOTH ENDS, CRIMP LARGE END, CRIMP BOTH ENDS AND UNDERSIZED - AT NO ADDITIONAL CHARGE.

**** NOTICE **** Catalog pricing is based on "standard pack" quantity. Non "standard pack" quantity orders may be subject to an additional charge.

Multi:

7/1/09

R5/1/10

5B-10



MODULAR METAL FABRICATORS INC.

Single Duct Attenuator Assembled Per Krueger Specifications - 1" Liner - 24 Gauge

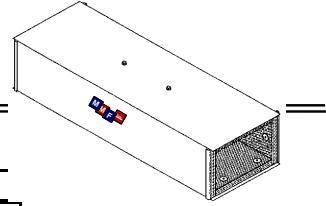

REVISED SIZE ON 24 X 16 SINGLE DUCT ATTENUATOR

LMHS	#4	#5	#6	#7	#8	#9
LIST PRICE	\$82.67	\$82.67	\$82.67	\$82.93	\$82.93	\$105.03

LMHS	#10	#12	#14	#16	#20	#22
LIST PRICE	\$105.03	\$106.13	\$123.47	\$146.47	\$195.60	\$195.60

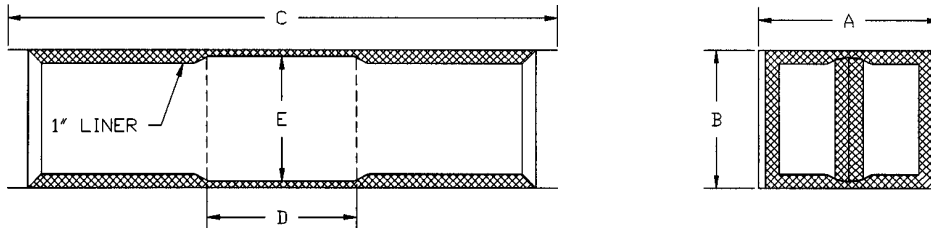

NO.	ATTENUATOR SIZE			BAFFLE SIZE		
	A	B	C	D	E	
4, 5, 6	12"	8"	36"	12"	7 1/2"	
7, 8	12"	10"	36"	12"	9 1/2"	
9, 10	14"	12 1/2"	36"	12"	12"	
12	16"	15"	36"	12"	14 1/2"	
14	20"	17 1/2"	36"	12"	17"	
16	24"	18"	36"	12"	17 1/2"	
22	38"	18"	36"	12"	17 1/2"	

Double Duct Attenuator Assembled Per Krueger Specifications - 1" Liner - 24 Gauge

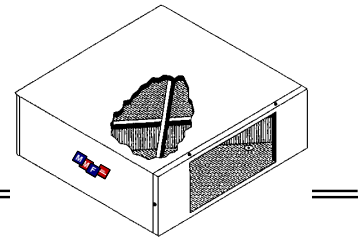

LMHD	#4	#5	#6	#7	#8
LIST PRICE	\$139.13	\$139.13	\$139.13	\$153.77	\$153.77

LMHD	#9	#10	#12	#14	#16
LIST PRICE	\$206.20	\$206.20	\$227.87	\$251.27	\$268.73

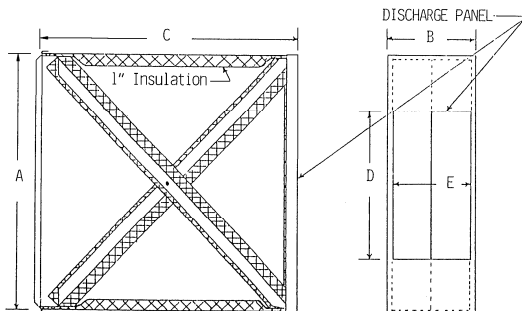

NO.	ATTENUATOR SIZE			DISCHARGE PANEL SIZE		
	A	B	C	D	E	
4, 5, 6	24 1/8"	8"	23"	14"	7 1/4"	
7, 8	24 1/8"	10"	23"	18"	9 1/4"	
9, 10	28 1/8"	12 1/2"	35"	22"	11 3/4"	
12	32 1/8"	15"	35"	25"	14 1/4"	
14	40 1/8"	17 1/2"	35"	30"	14 1/4"	
16	48 1/8"	18"	35"	34"	16 1/2"	

Multi: _____

7/1/09

R4/1/10

6B-10



MODULAR METAL FABRICATORS INC.

Single Duct Attenuator Assembled Per Titus Specifications - 1" Liner - 24 Gauge

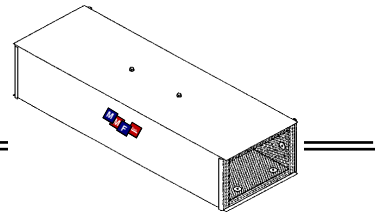

TITUS HAS CHANGED THE 24-16 SINGLE DUCT BACK TO 38" X 18"

ESV	#4	#5	#6	#7	#8
LIST PRICE	\$72.97	\$72.97	\$72.97	\$77.40	\$77.40

ESV	#9	#10	#12	#14	#16
LIST PRICE	\$86.63	\$86.63	\$104.90	\$118.60	\$132.27

ATTENUATOR SIZE			
NO.	A	B	C
4, 5, 6	12"	8"	36"
7, 8	12"	10"	36"
9, 10	14"	12 1/2"	36"
12	16"	15"	36"
14	20"	17 1/2"	36"
16	24"	18"	36"
24 - 16	38"	18"	36"

#24-16
\$152.20

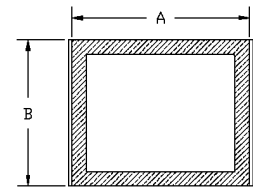
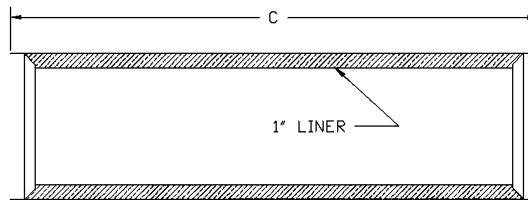

Double Duct Attenuator Assembled Per Titus Specifications - 1" Liner - 24 Gauge

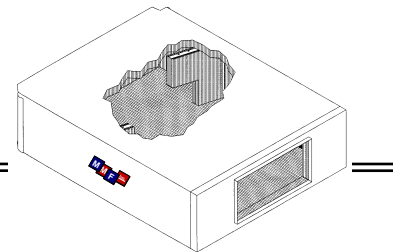

EDV	#4	#5	#6	#7	#8
LIST PRICE	\$145.97	\$145.97	\$145.97	\$155.07	\$155.07

EDV	#9	#10	#12	#14	#16
LIST PRICE	\$173.33	\$173.33	\$200.70	\$255.43	\$342.07

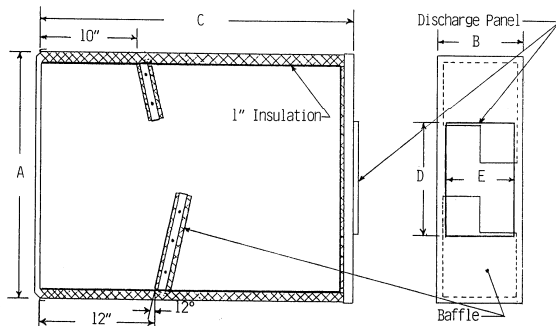

NO.	ATTENUATOR SIZE			DISCHARGE PANEL SIZE	
	A	B	C	D	E
4, 5, 6	24"	8"	30"	11 7/8"	5 7/8"
7, 8	24"	10"	30"	11 7/8"	9 7/8"
9, 10	28"	12 1/2"	30"	13 7/8"	12 7/8"
12	32"	15"	30"	15 7/8"	14 7/8"
14	40"	17 1/2"	36"	19 7/8"	17 3/8"
16	48"	18"	48"	23 7/8"	17 7/8"

Multi: _____

7/1/09

R4/1/10

7B-10



MODULAR METAL FABRICATORS INC.

Galvanized Spiral Pipe - Available Sizes 10 Foot Long - Bare – Raw One End, Crimp Other

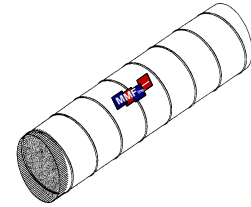

26 & 24 – Gauge - Raw One End, Crimp Other
22 ----- Gauge - Raw Both Ends

	26 Gauge	Part	24 Gauge	Part	22 Gauge	Part
SIZE	List Price	Number	List Price	Number	List Price	Number
4"	\$12.36	SPCRI1004	\$14.98	SPCRJ1004	\$24.16	SPRBK1004
5"	\$15.11	SPCRI1005	\$20.27	SPCRJ1005	\$32.70	SPRBK1005
6"	\$17.85	SPCRI1006	\$24.70	SPCRJ1006	\$39.84	SPRBK1006
7"	\$20.58	SPCRI1007	\$32.75	SPCRJ1007	\$46.24	SPRBK1007
8"	\$23.57	SPCRI1008	\$37.42	SPCRJ1008	\$54.32	SPRBK1008
9"	\$26.50	SPCRI1009	\$42.34	SPCRJ1009	\$61.13	SPRBK1009
10"	\$29.98	SPCRI1010	\$46.78	SPCRJ1010	\$67.68	SPRBK1010
12"	\$35.70	SPCRI1012	\$56.37	SPCRJ1012	\$82.70	SPRBK1012
14"	\$41.93	SPCRI1014	\$65.74	SPCRJ1014	\$94.97	SPRBK1014
16"	\$60.68	SPCRI1016	\$73.91	SPCRJ1016	\$108.98	SPRBK1016
18"	\$73.52	SPCRI1018	\$81.70	SPCRJ1018	\$113.81	SPRBK1018
20"	\$81.33	SPCRI1020	\$90.37	SPCRJ1020	\$119.71	SPRBK1020
22"			\$99.75	SPCRJ1022	\$126.91	SPRBK1022
24"			\$109.65	SPCRJ1024	\$131.58	SPRBK1024
26"			\$120.14	SPCRJ1026	\$144.50	SPRBK1026
28"			\$130.61	SPCRJ1028	\$155.36	SPRBK1028
30"			\$150.20	SPCRJ1030	\$166.07	SPRBK1030
32"			\$163.50	SPCRJ1032	\$178.36	SPRBK1032
34"			\$183.69	SPCRJ1034	\$226.72	SPRBK1034
36"			\$194.53	SPCRJ1036	\$240.21	SPRBK1036
38"			\$205.43	SPCRJ1038	\$253.46	SPRBK1038
40"			\$216.68	SPCRJ1040	\$266.72	SPRBK1040
42"			\$238.86	SPCRJ1042	\$279.98	SPRBK1042

**SIZES THAT ARE
"NON-STOCK"/"NON-STANDARD",
AND LESS THAN 50' PER SIZE
MAY BE SUBJECT TO THE FOLLOWING SET-UP CHARGES:
4" TO 24" - \$20.00 NET
26" TO 42" - \$40.00 NET**

** NOTICE **
Catalog pricing is based on a "standard pack" quantity.
Non "standard pack" quantity orders may be subject to an additional charge.

Prices effective 06-01-2010

Multi: _____

7/1/09

r6/1/10

13B-12



MODULAR METAL FABRICATORS INC.

90° 1 1/2 Times Radius Elbows

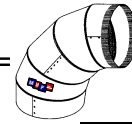

20" AND ABOVE, ALL GAUGES, ARE SPOTWELDED /NON-ADJUSTABLE. 4-18" SPOTWELDED /NON-ADJUSTABLE. CALL FOR QUOTE.

SIZE	RADIUS TO CENTER	LIST PRICE 28 GA	PART NUMBER	LIST PRICE 26 GA	PART NUMBER	LIST PRICE 24 GA	PART NUMBER	LIST PRICE 22 GA	PART NUMBER
4"	6"	\$7.42	ELXH04	\$8.77	ELXI04	\$9.26	ELXJ04	\$13.90	ELXK04
5"	7 1/2"	\$8.04	ELXH05	\$9.50	ELXI05	\$10.06	ELXJ05	\$15.08	ELXK05
6"	9"	\$9.02	ELXH06	\$10.64	ELXI06	\$11.26	ELXJ06	\$16.88	ELXK06
7"	10 1/2"	\$10.74	ELXH07	\$12.69	ELXI07	\$13.42	ELXJ07	\$20.14	ELXK07
8"	12"	\$12.82	ELXH08	\$15.15	ELXI08	\$16.09	ELXJ08	\$24.13	ELXK08
9"	13 1/2"	\$14.70	ELXH09	\$17.37	ELXI09	\$18.38	ELXJ09	\$27.59	ELXK09
10"	15"	\$15.94	ELXH10	\$18.82	ELXI10	\$19.94	ELXJ10	\$29.92	ELXK10
12"	18"	\$16.92	ELXH12	\$21.22	ELXI12	\$26.49	ELXJ12	\$39.73	ELXK12
14"	21"			\$24.78	ELXI14	\$30.99	ELXJ14	\$46.52	ELXK14
16"	24"			\$28.26	ELXI16	\$35.33	ELXJ16	\$52.97	ELXK16
18"	27"			\$31.90	ELXI18	\$39.83	ELXJ18	\$59.77	ELXK18
20"	30"					\$49.74	ELXJ20	\$74.64	ELXK20
22"	33"							\$104.49	ELXK22
24"	36"							\$146.26	ELXK24
26"	39"							\$237.88	ELXK26
28"	42"							\$272.58	ELXK28
30"	45"							\$321.43	ELXK30
32"	48"							\$353.67	ELXK32
34"	51"							\$375.75	ELXK34
36"	54"							\$397.87	ELXK36

Crimp both ends, Call for Quote.

45° 1 1/2 Times Radius Elbows

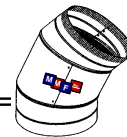

20" AND ABOVE, ALL GAUGES, ARE SPOTWELDED /NON-ADJUSTABLE. 4-18" SPOTWELDED /NON-ADJUSTABLE. CALL FOR QUOTE.

SIZE	RADIUS TO CENTER	LIST PRICE 28 GA	PART NUMBER	LIST PRICE 26 GA	PART NUMBER	LIST PRICE 24 GA	PART NUMBER	LIST PRICE 22 GA	PART NUMBER
4"	6"	\$4.19	ELZH04	\$4.89	ELZI04	\$5.90	ELZJ04	\$8.84	ELZK04
5"	7 1/2"	\$5.48	ELZH05	\$6.24	ELZI05	\$7.18	ELZJ05	\$10.78	ELZK05
6"	9"	\$6.45	ELZH06	\$7.73	ELZI06	\$8.91	ELZJ06	\$13.34	ELZK06
7"	10 1/2"	\$7.07	ELZH07	\$8.25	ELZI07	\$9.54	ELZJ07	\$14.28	ELZK07
8"	12"	\$8.08	ELZH08	\$9.46	ELZI08	\$10.95	ELZJ08	\$16.43	ELZK08
9"	13 1/2"	\$8.56	ELZH09	\$10.58	ELZI09	\$12.06	ELZJ09	\$18.13	ELZK09
10"	15"	\$9.46	ELZH10	\$10.78	ELZI10	\$12.51	ELZJ10	\$18.75	ELZK10
12"	18"	\$11.86	ELZH12	\$13.18	ELZI12	\$15.36	ELZJ12	\$23.06	ELZK12
14"	21"			\$18.41	ELZI14	\$21.66	ELZJ14	\$32.48	ELZK14
16"	24"			\$26.90	ELZI16	\$32.27	ELZJ16	\$48.39	ELZK16
18"	27"			\$31.54	ELZI18	\$34.77	ELZJ18	\$52.21	ELZK18
20"	30"					\$43.86	ELZJ20	\$65.76	ELZK20
22"	33"							\$98.66	ELZK22
24"	36"							\$109.41	ELZK24
26"	39"							\$178.33	ELZK26
28"	42"							\$189.31	ELZK28
30"	45"							\$251.68	ELZK30
32"	48"							\$291.75	ELZK32
34"	51"							\$324.17	ELZK34
36"	54"							\$344.31	ELZK36

Multi: _____

7/1/09

R5/1/10

14B-09



MODULAR METAL FABRICATORS INC.

Rectangular Saddle Taps - 6" High

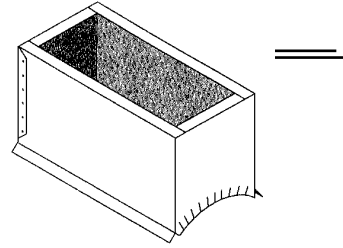

I. D. SIZE	LIST PRICE			
	28 GA	26 GA	24 GA	22 GA
10 x 4	\$22.18	\$23.40	\$28.60	\$42.88
10 x 6	\$22.85	\$24.10	\$29.46	\$44.20
12 x 4		\$24.10	\$29.46	\$44.20
12 x 6		\$24.82	\$30.34	\$45.52
12 x 8		\$25.55	\$31.27	\$46.87
14 x 4		\$24.82	\$30.34	\$45.52
14 x 6		\$25.55	\$31.27	\$46.87
14 x 8		\$26.31	\$32.21	\$48.29
16 x 6		\$26.31	\$32.21	\$48.29
16 x 8		\$27.11	\$33.14	\$49.74
16 x 10		\$27.94	\$34.18	\$51.24
16 x 12		\$28.78	\$35.18	\$52.76
16 x 14		\$29.64	\$36.22	\$54.32
18 x 6		\$27.11	\$33.14	\$49.74
18 x 8		\$27.94	\$34.18	\$51.24
18 x 10		\$28.78	\$35.18	\$52.76
18 x 12		\$29.64	\$36.22	\$54.32

FLANGE
 MUST STATE OD AND ID
 SIZES WHEN ORDERING
 3/4" FLANGE LONG SIDE
 3/4" DOVETAIL SHORT SIDE
 6" HIGH

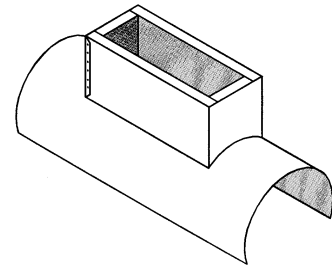

SKIRT
 MUST STATE OD AND ID
 SIZES WHEN ORDERING
 6" SKIRT
 6" HIGH

***PLEASE SPECIFY SKIRT OR FLANGE WHEN ORDERING**

**** NOTICE ****
 Catalog pricing is based on "standard pack"
 quantity.
 Non "standard pack" quantity orders may be subject

Multi: _____

7/1/09

15B-03



MODULAR METAL FABRICATORS INC.

Damper Disc - No Hardware

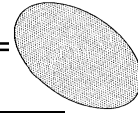

SIZE	LIST PRICE	PART NUMBER	LIST PRICE	PART NUMBER	LIST PRICE	PART NUMBER	LIST PRICE	PART NUMBER
	30 GA		28 GA		26 GA		24 GA	
4"	\$0.90	DMDG04	\$1.00	DMDH04	\$1.03	DMDI04	\$1.23	DMDJ04
5"	\$1.13	DMDG05	\$1.27	DMDH05	\$1.33	DMDI05	\$1.53	DMDJ05
6"	\$1.33	DMDG06	\$1.50	DMDH06	\$1.57	DMDI06	\$1.83	DMDJ06
7"	\$1.37	DMDG07	\$1.53	DMDH07	\$1.60	DMDI07	\$1.87	DMDJ07
8"	\$1.63	DMDG08	\$1.83	DMDH08	\$1.90	DMDI08	\$2.23	DMDJ08
9"	\$1.83	DMDG09	\$2.07	DMDH09	\$2.17	DMDI09	\$2.53	DMDJ09
10"	\$2.20	DMDG10	\$2.47	DMDH10	\$2.60	DMDI10	\$3.00	DMDJ10
12"	\$2.33	DMDG12	\$2.63	DMDH12	\$2.93	DMDI12	\$3.40	DMDJ12
14"			\$2.83	DMDH14	\$3.13	DMDI14	\$3.70	DMDJ14
16"			\$3.97	DMDH16	\$4.40	DMDI16	\$5.13	DMDJ16
18"			\$5.33	DMDH18	\$5.90	DMDI18	\$6.43	DMDJ18
20"					\$7.63	DMDI20	\$9.23	DMDJ20
22"					\$9.77	DMDI22	\$11.83	DMDJ22
24"					\$12.93	DMDI24	\$15.67	DMDJ24
26"							\$16.07	DMDJ26

Damper Disc - With Hardware

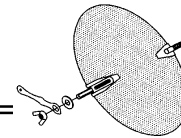

SIZE	LIST PRICE	PART NUMBER	LIST PRICE	PART NUMBER	LIST PRICE	PART NUMBER	LIST PRICE	PART NUMBER
	30 GA		28 GA		26 GA		24 GA	
4"	\$3.53	DMHG04	\$3.93	DMHH04	\$4.13	DMHI04	\$4.83	DMHJ04
5"	\$3.73	DMHG05	\$4.17	DMHH05	\$4.33	DMHI05	\$5.10	DMHJ05
6"	\$4.07	DMHG06	\$4.57	DMHH06	\$4.77	DMHI06	\$5.57	DMHJ06
7"	\$4.40	DMHG07	\$4.90	DMHH07	\$5.13	DMHI07	\$6.03	DMHJ07
8"	\$4.60	DMHG08	\$5.17	DMHH08	\$5.40	DMHI08	\$6.33	DMHJ08
9"	\$4.97	DMHG09	\$5.53	DMHH09	\$5.80	DMHI09	\$6.80	DMHJ09
10"	\$5.27	DMHG10	\$5.93	DMHH10	\$6.17	DMHI10	\$7.23	DMHJ10
12"	\$7.67	DMHG12	\$8.53	DMHH12	\$8.97	DMHI12	\$10.53	DMHJ12
14"			\$9.17	DMHH14	\$10.17	DMHI14	\$11.83	DMHJ14
16"			\$11.47	DMHH16	\$12.73	DMHI16	\$14.80	DMHJ16
18"			\$13.63	DMHH18	\$15.13	DMHI18	\$17.60	DMHJ18
20"					\$16.77	DMHI20	\$20.30	DMHJ20
22"					\$19.90	DMHI22	\$24.07	DMHJ22
24"					\$23.77	DMHI24	\$28.77	DMHJ24
26"							\$31.40	DMHJ26

**INCLUDES:
2 BEARINGS
1 HANDLE
2 WASHERS
2 WING NUTS**

**AVAILABLE
IN OTHER
HARDWARE,
PLEASE
CALL FOR
PRICING.**

**** NOTICE **** Catalog pricing is based on a "standard pack" quantity.
Non "standard pack" quantity orders may be subject to an additional charge.

Multi: _____

Effective 1/1/07

7/1/09

r5/1/10

16B-03



MODULAR METAL FABRICATORS INC.

Sleeve with Damper Installed Bead & Crimp One End – Damper Installed in Center of Sleeve

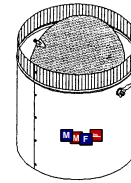

SIZE	LIST PRICE	PART NUMBER	LIST PRICE	PART NUMBER	LIST PRICE	PART NUMBER
	30 GA		28 GA		26 GA	
4"	\$4.37	DMSG0406GBC	\$5.80	DMSH0406HBC	\$6.40	DMSI0406IBC
5"	\$4.67	DMSG0507GBC	\$5.90	DMSH0507HBC	\$6.47	DMSI0507IBC
6"	\$5.00	DMSG0608GBC	\$6.13	DMSH0608HBC	\$6.67	DMSI0608IBC
7"	\$5.40	DMSG0709GBC	\$6.43	DMSH0709HBC	\$6.97	DMSI0709IBC
8"	\$5.77	DMSG0810GBC	\$6.63	DMSH0810HBC	\$7.27	DMSI0810IBC
9"	\$6.17	DMSG0911GBC	\$7.10	DMSH0911HBC	\$7.53	DMSI0911IBC
10"	\$6.33	DMSG1012GBC	\$7.27	DMSH1012HBC	\$7.77	DMSI1012IBC
12"	\$7.03	DMSG1214GBC	\$7.93	DMSH1214HBC	\$8.93	DMSI1214IBC
14"			\$8.20	DMSH1416HBC	\$9.73	DMSI1416IBC
16"			\$8.67	DMSH1618HBC	\$10.37	DMSI1618IBC
18"			\$9.27	DMSH1820HBC	\$11.47	DMSI1820IBC
20"					\$17.13	DMSI2022IBC

4" – 8" = 9" HIGH
 9" – 10" = 12" HIGH
 12" – 14" = 15" HIGH
 16" – 20" = 18" HIGH

SIZE	LIST PRICE	PART NUMBER	LIST PRICE	PART NUMBER
	24 GA		22 GA	
4"	\$7.33	DMSJ0406JBC	\$12.63	DMSK0406KBC
5"	\$7.47	DMSJ0506JBC	\$12.83	DMSK0507KBC
6"	\$7.63	DMSJ0608JBC	\$13.10	DMSK0608KBC
7"	\$8.03	DMSJ0709JBC	\$13.77	DMSK0709KBC
8"	\$8.37	DMSJ0810JBC	\$14.37	DMSK0810KBC
9"	\$8.67	DMSJ0911JBC	\$14.93	DMSK0911KBC
10"	\$8.97	DMSJ1012JBC	\$15.43	DMSK1012KBC
12"	\$10.23	DMSJ1214JBC	\$17.63	DMSK1214KBC
14"	\$11.23	DMSJ1416JBC	\$19.33	DMSK1416KBC
16"	\$11.93	DMSJ1618JBC	\$20.50	DMSK1618KBC
18"	\$12.83	DMSJ1820JBC	\$22.13	DMSK1820KBC
20"	\$19.80	DMSJ2022JBC	\$37.67	DMSK2022KBC
22"	\$20.90	DMSJ2224JBC	\$41.37	DMSK2224KBC
24"	\$24.27	DMSJ2426JBC	\$48.03	DMSK2426KBC
26"	\$27.53	DMSJ2628JBC	\$54.77	DMSK2628KBC

4" THRU 26"
 INCLUDES:
 2 – BEARING
 1 – TIP
 1 – HANDLE
 2 – WASHERS
 2 – WING NUTS

**** NOTICE ****
 Catalog pricing is based on a "standard pack" quantity.
 Non "standard pack" quantity orders may be subject to an additional charge

Multi: _____

7/1/09

17B-03



MODULAR METAL FABRICATORS INC.

Galvanized Metal Sheets

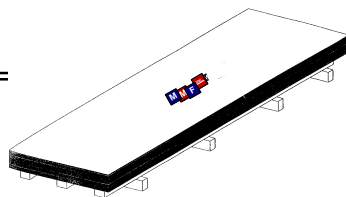

GAUGE	WIDTH	LENGTH	LIST PRICE	PART NUMBER
30	36	120	C A L L F O R P R I C I N G	MSSG 36120
30	36	96		MSSG 3696
28	36	120		MSSH 36120
28	36	96		MSSH 3696
28	48	120		MSSH 48120
28	48	96		MSSH 4896
26	36	120		MSSI 36120
26	36	96		MSSI 3696
26	48	120		MSSI 48120
26	48	96		MSSI 4896
24	36	120		MS SJ 36120
24	36	96		MS SJ 3696
24	48	120		MS SJ 48120
24	48	96		MS SJ 4896
22	36	120		MS SK 36120
22	36	96		MS SK 3696
22	48	120		MS SK 48120
22	48	96		MS SK 4896

**PALLET DEPOSIT
CHARGE OF \$25.00 NET.
CREDIT ISSUED UPON
RETURN.**

Galvanized Hardware Cloth - 1/4" size

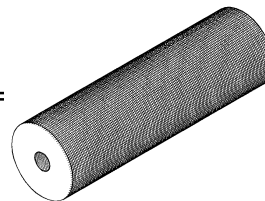

SIZE	LIST PRICE	PART NUMBER
1/4"	\$178.84	XXHCQ36100

**HARDWARE CLOTH IS
SOLD IN ROLLS 36" WIDE
X 100' LONG**

**** NOTICE ****
Catalog pricing is based on a "standard pack" quantity.
Non "standard pack" quantity orders may be subject to an additional charge.

Multi: _____

7/1/09

7/19/11

18B-07



MODULAR METAL FABRICATORS INC.

Eyebrow / Wall Cap with Mesh

Standard with 3/4" Stucco stop – PG – 1/4 Mesh

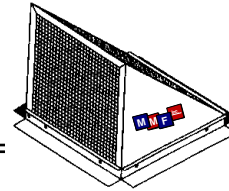

SIZE	LIST PRICE	PART NUMBER	LIST PRICE	PART NUMBER	ADD FOR BACK DRAFT DAMPER	ADD FOR 6" EXTENTION		LIST PRICE
	28 GALV.		28 BOND.			SIZE	RD	
3 x 3	\$7.00	MPEH0303	\$7.00	MPEHH0303	\$3.50	3"	RD	\$3.60
4 x 4	\$7.00	MPEH0404	\$7.00	MPEHH0404	\$3.50	4"	RD	\$3.60
5 x 5	\$8.03	MPEH0505	\$8.03	MPEHH0505	\$3.73	5"	RD	\$3.77
6 x 6	\$9.07	MPEH0606	\$9.07	MPEHH0606	\$3.77	6"	RD	\$3.93
7 x 7	\$9.60	MPEH0707	\$9.60	MPEHH0707	\$3.87	7"	RD	\$4.20
8 x 8	\$11.10	MPEH0808	\$11.10	MPEHH0808	\$4.13	8"	RD	\$4.93
10 x 4	\$12.20	MPEH1004	\$12.20	MPEHH1004	\$4.93	10"	RD	\$6.50
10 x 6	\$12.70	MPEH1006	\$12.70	MPEHH1006	\$5.50	12"	RD	\$7.87
10 x 10	\$13.70	MPEH1010	\$13.70	MPEHH1010	\$6.87	14"	RD	\$9.10
12 x 4	\$12.70	MPEH1204	\$12.70	MPEHH1204	\$5.50			
12 x 6	\$13.40	MPEH1206	\$13.40	MPEHH1206	\$6.17			
12 x 12	\$15.20	MPEH1212	\$15.20	MPEHH1212	\$8.23			
14 x 10	\$15.20	MPEH1410	\$15.20	MPEHH1410	\$8.23			
14 x 14	\$18.23	MPEH1414	\$18.23	MPEHH1414	\$9.60			
30 x 8	\$29.47	MPEH3008	\$29.47	MPEHH3008	\$13.00			
30 x 10	\$29.47	MPEH3010	\$29.47	MPEHH3010	\$13.70			

AVAILABLE IN 26 GA GALV./BOND. --ADD 11%
ADD 28 % FOR 24 GA GALVANIZED

Refrigeration Eyebrow

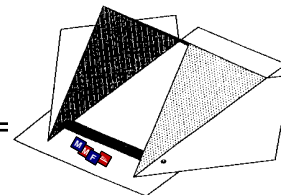

SIZE	LIST PRICE 28 GALV.	PART NUMBER
4" x 4"	\$4.73	MPERH0404

ADVISORY: When installing product, Apply Sealant when/where necessary.

**** NOTICE ****
Catalog pricing is based on "standard pack" quantity. Non "standard pack" quantity orders may be subject to an additional charge.

Multi: _____

7/1/09

1C-03



MODULAR METAL FABRICATORS INC.

Dryer Vents

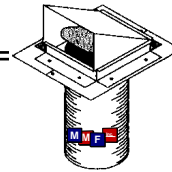

SIZE	LIST PRICE 28 GALV.	PART NUMBER	LIST PRICE 28 BOND.	PART NUMBER	LIST PRICE 26 GALV.	PART NUMBER	LIST PRICE 26 BOND.	PART NUMBER	LIST PRICE 24 GALV.	PART NUMBER
4"	\$13.40	MPVSH04	\$14.13	MPVSHH04	\$14.87	MPVSI04	\$15.70	MPVSIH04	\$18.03	MPVSJ04
5"	\$16.77	MPVSH05	\$18.18	MPVSHH05	\$18.60	MPVSI05	\$20.10	MPVSIH05	\$22.57	MPVSJ05
6"	\$16.77	MPVSH06	\$18.18	MPVSHH06	\$18.60	MPVSI06	\$20.10	MPVSIH06	\$22.57	MPVSJ06
7"	\$17.63	MPVSH07	\$19.10	MPVSHH07	\$19.60	MPVSI07	\$21.20	MPVSIH07	\$23.67	MPVSJ07
8"	\$17.63	MPVSH08	\$19.10	MPVSHH08	\$19.60	MPVSI08	\$21.20	MPVSIH08	\$23.67	MPVSJ08

Sproul Dryer Vent

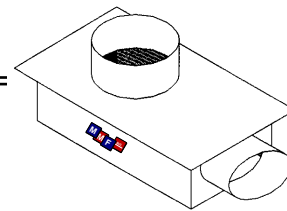

SIZE	LIST PRICE 28 GALV.	PART NUMBER
4" X 3" TO 4" RD	\$13.37	MPVLH040304
4" x 4"	\$13.37	MPVLH0404

Bliss Dryer Vent

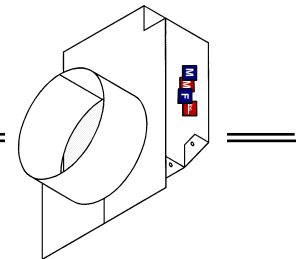

SIZE	LIST PRICE 28 GALV.	PART NUMBER
4" X 3" TO 4" RD	\$13.37	MPVBH040304

ADVISORY: When installing product,
Apply Sealant when/where necessary.

**** NOTICE ****

Catalog pricing is based on "standard pack" quantity.
Non "standard pack" quantity orders may be subject to
an additional charge.

Multi: _____

7/1/09

R5/1/10

2C-03



MODULAR METAL FABRICATORS INC.

14" x 6" Foundation Vents

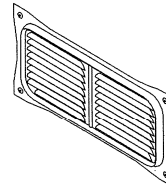

STAMPED

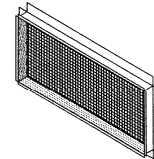

STUCCO

Galvanized

TYPE	LIST PRICE	PART NUMBER	LIST PRICE	PART NUMBER
	28 GA		26 GA	
STAMPED - 1/4" MESH	\$4.19	RGFMQH1406	\$4.96	RGFMQI1406
STAMPED - 1/8" MESH	\$4.61	RGFMEH1406	\$5.44	RGFMEI1406
STAMPED - NO MESH	\$2.74	RGFMH1406	\$3.22	RGFMI1406
STUCCO - 1/4" MESH	\$3.19	RGFSQH1406	\$3.54	RGFSQI1406
STUCCO - 1/8" MESH	\$3.54	RGFSEH1406	\$4.19	RGFSEI1406

Standard Pack Quantities

25/Bundle

With No Mesh

50/Bundle

Bonderized

TYPE	LIST PRICE	PART NUMBER	LIST PRICE	PART NUMBER
	28 GA		26 GA	
STAMPED - 1/4" MESH	\$4.54	RGFMQHH1406	\$5.34	RGFMQIH1406
STAMPED - 1/8" MESH	\$5.02	RGFMEHH1406	\$5.86	RGFMEIH1406
STAMPED - NO MESH	\$2.94	RGFMHH1406	\$3.46	RGFMIH1406
STUCCO - 1/4" MESH	\$3.36	RGFSQHH1406	\$3.67	RGFSQIH1406
STUCCO - 1/8" MESH	\$3.85	RGFSEHH1406	\$4.50	RGFSEIH1406

ADVISORY: When installing product, Apply Sealant when/where necessary.

**** NOTICE ****

Catalog pricing is based on "standard pack" quantity. Non "standard pack" quantity orders may be subject to an additional charge.

Multi: _____

7/1/09

R5/1/10

3C-15



MODULAR METAL FABRICATORS INC.

T-Tops 6" High Std. Base - 28 GA Galvanized

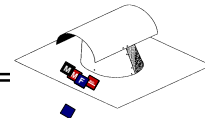

SIZE	LIST PRICE	PART NUMBER	LIST PRICE	PART NUMBER	LIST PRICE	PART NUMBER
	28 GA		1/4" HDW		1/8" HDW	
3"	\$9.10	TFH03S	\$10.30	TFH03SH4	\$10.77	TFH03SH8
4"	\$9.10	TFH04S	\$10.30	TFH04SH4	\$10.77	TFH04SH8
5"	\$9.10	TFH05S	\$10.30	TFH05SH4	\$10.77	TFH05SH8
7"	\$10.30	TFH07S	\$11.53	TFH07SH4	\$12.07	TFH07SH8
8"	\$16.80	TFH08S	\$18.80	TFH08SH4	\$22.77	TFH08SH8
10"	\$25.20	TFH10S	\$28.47	TFH10SH4	\$29.73	TFH10SH8
12"	\$40.37	TFH12S	\$45.60	TFH12SH4	\$47.63	TFH12SH8
14"	\$55.70	TFH14S	\$62.93	TFH14SH4	\$65.70	TFH14SH8

BASE SIZES
 4" = 15" x 18"
 5" = 16" x 18"
 7" = 20" x 18"

T-Tops 6" High Std. Base - 28 GA Bonderized

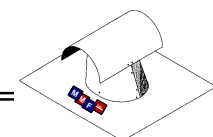

SIZE	LIST PRICE	PART NUMBER	LIST PRICE	PART NUMBER	LIST PRICE	PART NUMBER
	28 GA		1/4" HDW		1/8" HDW	
3"	\$10.00	TFHH03S	\$11.30	TFHH03SH4	\$11.83	TFHH03SH8
4"	\$10.00	TFHH04S	\$11.30	TFHH04SH4	\$11.83	TFHH04SH8
5"	\$10.00	TFHH05S	\$11.30	TFHH05SH4	\$11.83	TFHH05SH8
7"	\$11.30	TFHH07S	\$12.70	TFHH07SH4	\$13.27	TFHH07SH8
8"	\$17.63	TFHH08S	\$18.80	TFHH08SH4	\$19.73	TFHH08SH8
10"	\$27.73	TFHH10S	\$30.50	TFHH10SH4	\$32.70	TFHH10SH8
12"	\$44.37	TFHH12S	\$50.13	TFHH12SH4	\$52.33	TFHH12SH8
14"	\$61.20	TFHH14S	\$69.17	TFHH14SH4	\$72.23	TFHH14SH8

BASE SIZES
 4" = 15" x 18"
 5" = 16" x 18"
 7" = 20" x 18"

T-Tops 6" High Shake Base - 28 GA

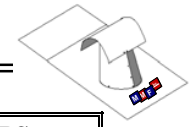

SIZE	LIST PRICE	PART NUMBER	LIST PRICE	PART NUMBER
	GALV.		BOND.	
3"	\$10.77	TFJH03S	\$11.83	TFJHH03S
4"	\$10.77	TFJH04S	\$11.83	TFJHH04S
5"	\$10.77	TFJH05S	\$11.83	TFJHH05S
7"	\$12.17	TFJH07S	\$13.40	TFJHH07S
8"	\$19.33	TFJH08S	\$21.17	TFJHH08S
10"	\$27.73	TFJH10S	\$27.70	TFJHH10S

**FOR ALL T-TOPS:
 SIZES 8" & ABOVE,
 FOR END CAPS,
 Or TO SOLDER
 Call for Quote.**

BASE SIZES
 4" = 15" x 26"
 5" = 16" x 26"
 7" = 18" x 28"

ADVISORY: When installing product,
 Apply Sealant when/where necessary.

**** NOTICE **** Catalog pricing is based on a "standard pack" quantity.
 Non "standard pack" quantity orders may be subject to an additional charge.

Multi: _____

7/1/09

r5/1/10

4C-03



MODULAR METAL FABRICATORS INC.

T-Tops 6" High Dead Soft Aluminum

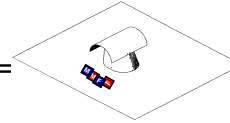

SIZE	LIST PRICE DSA	PART NUMBER	NUMBER PER CARTON
4"	\$22.27	TFA04S	5
7"	\$25.60	TFA07S	5

BASE SIZES
 4" = 24" x 24"
 7" = 24" x 24"

Starter Jacks - For Aluminum T-Tops

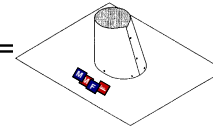

SIZE	LIST PRICE DSA	PART NUMBER	LIST PRICE 28 GALV.	PART NUMBER	LIST PRICE 28 BOND.	PART NUMBER
	4"	\$18.97	TFSA04	\$7.77	TFSH04	\$8.37
7"	\$21.97	TFSA07	\$8.77	TFSH07	\$9.47	TFSHH07

BASE / DSA	BASE / GAL	BASE / BOND
4"--24 X 24	4"--15 X 18	4"--15 X 18
7"--28 X 24	7"--20 X 18	7"--20 X 18

China Caps - Galvanized No Screen - Crimp Cap - 3 Stays Spotwelded

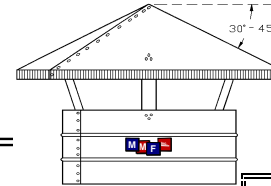

SIZE	LIST PRICE 28 GA	PART NUMBER	LIST PRICE 26 GA	PART NUMBER	LIST PRICE 24 GA	PART NUMBER	ADD FOR SCREEN
4"	\$7.84	TFCH04	\$8.90	TFCI04	\$10.67	TFCJ04	\$1.20
5"	\$8.21	TFCH05	\$9.41	TFCI05	\$11.79	TFCJ05	\$1.20
6"	\$10.04	TFCH06	\$11.46	TFCI06	\$13.50	TFCJ06	\$1.40
7"	\$11.30	TFCH07	\$12.89	TFCI07	\$15.14	TFCJ07	\$1.57
8"	\$14.53	TFCH08	\$16.50	TFCI08	\$19.31	TFCJ08	\$2.97
9"	\$22.13	TFCH09	\$25.04	TFCI09	\$29.13	TFCJ09	\$3.13
10"	\$35.53	TFCH10	\$40.04	TFCI10	\$48.84	TFCJ10	\$4.70
12"	\$40.93	TFCH12	\$46.10	TFCI12	\$53.41	TFCJ12	\$6.47
14"	\$46.50	TFCH14	\$52.32	TFCI14	\$60.57	TFCJ14	\$8.43

THE ANGLE OF THE CAP IS KEPT BETWEEN 45° AND 30° TO PREVENT RAIN FROM BLOWING UNDER THE CAP AND INTO THE PIPE.

BONDERIZED - ONLY MANUFACTURED IN 26 GAUGE, CALL FOR QUOTE.

ADVISORY: When installing product, Apply Sealant when/where necessary.

** NOTICE ** Catalog pricing is based on a "standard pack" quantity. Non "standard pack" quantity orders may be subject to an additional charge.

Multi: _____

7/1/09

r5/1/10

5C-03



MODULAR METAL FABRICATORS INC.

Flashing for Rotary Vents Sealed 6" High - 6" Skirt - *Bead & Crimp*

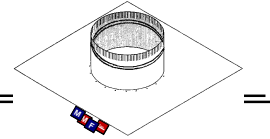

SIZE	LIST PRICE 28 GA	PART NUMBER	LIST PRICE 26 GA	PART NUMBER	LIST PRICE 24 GA	PART NUMBER
10"	\$16.47	TFRH1006BC	\$18.30	TFRH1006BC	\$22.13	TFRJ1006BC
12"	\$17.87	TFRH1206BC	\$19.83	TFRH1206BC	\$23.97	TFRJ1206BC
14"	\$21.47	TFRH1406BC	\$23.83	TFRH1406BC	\$28.83	TFRJ1406BC
16"	\$23.00	TFRH1606BC	\$25.53	TFRH1606BC	\$30.90	TFRJ1606BC
18"			\$29.07	TFRH1806BC	\$35.17	TFRJ1806BC
20"			\$31.03	TFRH2006BC	\$37.53	TFRJ2006BC
22"			\$33.23	TFRH2206BC	\$40.20	TFRJ2206BC
24"			\$35.43	TFRH2406BC	\$42.83	TFRJ2406BC
26"					\$49.43	TFRJ2606BC

**PLEASE SPECIFY:
BEAD & CRIMP
CRIMP ONLY
BEAD ONLY**

Conductor Pipe Flashing Sealed 5" High - 6" Skirt

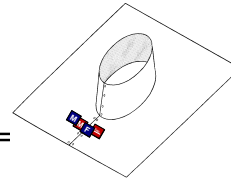

SIZE	LIST PRICE DSA	PART NUMBER	LIST PRICE 28 GA	PART NUMBER	LIST PRICE 26 GA	PART NUMBER	LIST PRICE 24 GA	PART NUMBER
3"	\$36.67	TYCA03S	\$6.87	TYCH03S	\$7.70	TYCI03S	\$9.33	TYCJ03S
4"	\$40.60	TYCA04S	\$9.13	TYCH04S	\$10.27	TYCI04S	\$12.43	TYCJ04S
5"	\$50.77	TYCA05S	\$11.47	TYCH05S	\$12.87	TYCI05S	\$15.57	TYCJ05S
6"	\$60.90	TYCA06S	\$13.77	TYCH06S	\$15.47	TYCI06S	\$18.73	TYCJ06S
7"	\$71.13	TYCA07S	\$14.03	TYCH07S	\$15.77	TYCI07S	\$19.07	TYCJ07S
8"	\$81.23	TYCA08S	\$14.27	TYCH08S	\$16.03	TYCI08S	\$19.37	TYCJ08S
9"	\$91.33	TYCA09S	\$15.50	TYCH09S	\$17.43	TYCI09S	\$21.07	TYCJ09S
10"	\$101.50	TYCA10S	\$20.87	TYCH10S	\$23.47	TYCI10S	\$28.40	TYCJ10S
12"	\$118.37	TYCA12S	\$21.93	TYCH12S	\$24.63	TYCI12S	\$29.80	TYCJ12S
14"	\$138.13	TYCA14S	\$30.53	TYCH14S	\$34.33	TYCI14S	\$41.53	TYCJ14S
16"	\$157.87	TYCA16S	\$39.13	TYCH16S	\$43.97	TYCI16S	\$53.20	TYCJ16S
18"	\$177.60	TYCA18S	\$47.23	TYCH18S	\$53.10	TYCI18S	\$64.23	TYCJ18S
20"	\$197.33	TYCA20S	\$58.93	TYCH20S	\$66.20	TYCI20S	\$75.93	TYCJ20S
22"	\$217.07	TYCA22S	\$66.00	TYCH22S	\$74.17	TYCI22S	\$89.77	TYCJ22S
24"	\$236.80	TYCA24S	\$70.60	TYCH24S	\$79.33	TYCI24S	\$96.00	TYCJ24S

ADVISORY: When installing product,
Apply Sealant when/where necessary.

**** NOTICE **** Catalog pricing is based on a "standard pack" quantity.
Non "standard pack" quantity orders may be subject to an additional charge.

Multi: _____

7/1/09

r5/1/10

6C-03



MODULAR METAL FABRICATORS INC.

Style A Plain - Elbows -- For Downspout

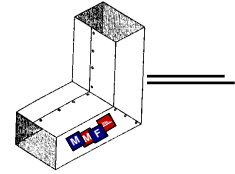

Galvanized

SIZE	LIST PRICE	PART NUMBER	LIST PRICE	PART NUMBER	LIST PRICE	PART NUMBER
	28 GA		26 GA		24 GA	
2 x 3	\$4.71	RGDAH020390	\$5.58	RGDAI020390	\$7.00	RGDAJ020390
2 x 4	\$7.66	RGDAH020490	\$9.05	RGDAI020490	\$11.30	RGDAJ020490
3 x 4	\$6.62	RGDAH030490	\$7.80	RGDAI030490	\$9.78	RGDAJ030490
4 x 6	\$8.91	RGDAH040690	\$11.20	RGDAI040690	\$13.90	RGDAJ040690

Shown @ 90°

Bonderized

SIZE	LIST PRICE	PART NUMBER	LIST PRICE	PART NUMBER
	28 GA		26 GA	
2 x 3	\$5.51	RGDAH020390	\$6.62	RGDAIH020390
2 x 4	\$8.32	RGDAH020490	\$9.81	RGDAIH020490
3 x 4	\$7.70	RGDAH030490	\$9.15	RGDAIH030490
4 x 6	\$9.36	RGDAH040690	\$9.91	RGDAIH040690

Style B Plain Elbows -- For Downspout

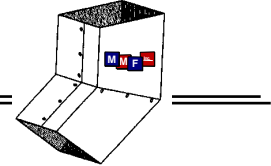

Galvanized

SIZE	LIST PRICE	PART NUMBER	LIST PRICE	PART NUMBER	LIST PRICE	PART NUMBER
	28 GA		26 GA		24 GA	
2 x 3	\$6.69	RGDBH020345	\$7.87	RGDBI020345	\$9.85	RGDBJ020345
2 x 4	\$10.85	RGDBH020445	\$12.86	RGDBI020445	\$16.05	RGDBJ020445
3 x 4	\$7.46	RGDBH030445	\$8.77	RGDBI030445	\$10.95	RGDBJ030445
4 x 6	\$12.76	RGDBH040645	\$15.94	RGDBI040645	\$19.97	RGDBJ040645

Shown @ 45°

Bonderized

SIZE	LIST PRICE	PART NUMBER	LIST PRICE	PART NUMBER
	28 GA		26 GA	
2 x 3	\$7.00	RGDBHH020345	\$8.25	RGDBIH020345
2 x 4	\$11.72	RGDBHH020445	\$13.86	RGDBIH020445
3 x 4	\$7.70	RGDBHH030445	\$9.15	RGDBIH030445
4 x 6	\$14.14	RGDBHH040645	\$17.68	RGDBIH040645

ADVISORY: When installing product, Apply Sealant when/where necessary.

**** NOTICE **** Catalog pricing is based on a "standard pack" quantity. Non "standard pack" quantity orders may be subject to an additional charge.

Multi: _____

7/1/09

8C-15



MODULAR METAL FABRICATORS INC.

Conductor Pipe - Per 10' Length

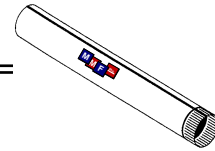

Galvanized

SIZE	LIST PRICE	PART NUMBER	LIST PRICE	PART NUMBER	LIST PRICE	PART NUMBER	LIST PRICE	PART NUMBER
	30 GA		28 GA		26 GA		24 GA	
3"	\$8.75	RGCPG1003	\$9.10	RGCPH1003	\$13.00	RGCP1003		
4"	\$10.69	RGCPG1004	\$11.06	RGCPH1004	\$16.59	RGCP1004		
5"	\$18.26	RGCPG1005	\$18.57	RGCPH1005	\$27.42	RGCP1005	\$33.49	RGCPJ1005
6"			\$21.65	RGCPH1006	\$30.44	RGCP1006	\$35.70	RGCPJ1006
7"			\$24.33	RGCPH1007	\$35.98	RGCP1007	\$44.90	RGCPJ1007
8"					\$38.30	RGCP1008	\$47.91	RGCPJ1008
9"					\$44.17	RGCP1009	\$54.15	RGCPJ1009
10"					\$46.14	RGCP1010	\$57.69	RGCPJ1010
12"					\$56.71	RGCP1012	\$69.65	RGCPJ1012
14"					\$68.09	RGCP1014	\$85.14	RGCPJ1014
16"					\$77.90	RGCP1016	\$103.83	RGCPJ1016

3" & 4" --
5 PER BANDED
BUNDLE.
NO BROKEN
BUNDLES
PLEASE
5" & UP --
LOOSE.

Vent Pipe - Per 30" Length - Galvanized

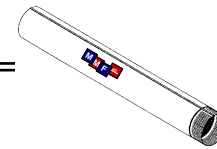

SIZE	NET PRICE	PART NUMBER	NET PRICE	PART NUMBER	NET PRICE	PART NUMBER
	30 GA		28 GA		26 GA	
3"	\$1.91	RGVPG3003	\$2.15	RGVPH3003	\$2.67	RGVPI3003
4"	\$2.27	RGVPG3004	\$2.55	RGVPH3004	\$3.19	RGVPI3004

3" -- 36 PER
CARTON.
4" -- 20 PER
CARTON.
NO
BROKEN
CARTONS
PLEASE

** NOTICE ** Catalog pricing is based on a "standard pack" quantity.
Non "standard pack" quantity orders may be subject to an additional charge.

Multi: _____

7/1/09

9C-15



Leader Heads

Galvanized

SIZE	LIST PRICE	PART NUMBER	LIST PRICE	PART NUMBER	LIST PRICE	PART NUMBER
	28 GA		26 GA		24 GA	
2 x 3	\$12.86	RGLH0203	\$15.67	RGLI0203	\$19.58	RGLJ0203
2 x 4	\$20.94	RGLH0204	\$24.72	RGLI0204	\$28.22	RGLJ0204
3 x 4	\$14.63	RGLH0304	\$17.82	RGLI0304	\$22.29	RGLJ0304
4 x 6	\$17.40	RGLH0406	\$21.25	RGLI0406	\$26.55	RGLJ0406

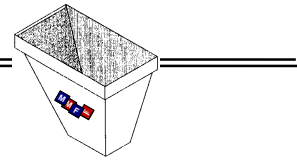

Bonderized

SIZE	LIST PRICE	PART NUMBER	LIST PRICE	PART NUMBER
	28 GA		26 GA	
2 x 3	\$13.86	RGLHH0203	\$17.75	RGLIH0203
2 x 4	\$22.60	RGLHH0204	\$26.70	RGLIH0204
3 x 4	\$15.81	RGLHH0304	\$19.58	RGLIH0304
4 x 6	\$18.79	RGLHH0406	\$22.85	RGLIH0406

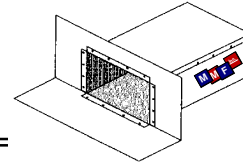

Scupper

Galvanized

SIZE	LIST PRICE	PART NUMBER			LIST PRICE	PART NUMBER			LIST PRICE	PART NUMBER		
	28 GA	RIGHT	CENTER	LEFT	26 GA	RIGHT	CENTER	LEFT	24 GA	RIGHT	CENTER	LEFT
2x3	\$9.22	RGSRH0203	RGSCH0203	RGLSH0203	\$11.20	RGSRI0203	RGSCI0203	RGLSI0203	\$14.04	RGSRJ0203	RGSCJ0203	RGLSJ0203
2x4	\$15.00	RGSRH0204	RGSCH0204	RGLSH0204	\$17.71	RGSRI0204	RGSCI0204	RGLSI0204	\$22.12	RGSRJ0204	RGSCJ0204	RGLSJ0204
3x4	\$11.02	RGSRH0304	RGSCH0304	RGLSH0304	\$13.42	RGSRI0304	RGSCI0304	RGLSI0304	\$16.82	RGSRJ0304	RGSCJ0304	RGLSJ0304
4x6	\$13.38	RGSRH0406	RGSCH0406	RGLSH0406	\$16.33	RGSRI0406	RGSCI0406	RGLSI0406	\$20.42	RGSRJ0406	RGSCJ0406	RGLSJ0406

Bonderized

SIZE	LIST PRICE	PART NUMBER			LIST PRICE	PART NUMBER		
	28 GA	RIGHT	CENTER	LEFT	26 GA	RIGHT	CENTER	LEFT
2 x 3	\$9.95	RGSRHH0203	RGSCHH0203	RGLLHH0203	\$12.48	RGSRIH0203	RGSCIH0203	RGLSIH0203
2 x 4	\$16.15	RGSRHH0204	RGSCHH0204	RGLLHH0204	\$19.10	RGSRIH0204	RGSCIH0204	RGLSIH0204
3 x 4	\$11.93	RGSRHH0304	RGSCHH0304	RGLLHH0304	\$14.94	RGSRIH0304	RGSCIH0304	RGLSIH0304
4 x 6	\$14.49	RGSRHH0406	RGSCHH0406	RGLLHH0406	\$18.17	RGSRIH0406	RGSCIH0406	RGLSIH0406

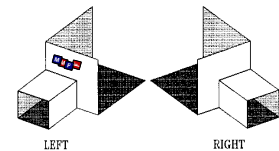

Scupper Splitter / Overflow

Galvanized

SIZE	LIST PRICE	PART NUMBER	LIST PRICE	PART NUMBER	LIST PRICE	PART NUMBER
	28 GA		26 GA		24 GA	
2 x 3	\$12.66	RGOCH0203	\$15.46	RGOCH0203	\$19.27	RGOCH0203
2 x 4	\$20.62	RGOCH0204	\$24.34	RGOCH0204	\$30.40	RGOCH0204
3 x 4	\$14.98	RGOCH0304	\$18.27	RGOCH0304	\$22.81	RGOCH0304
4 x 6	\$17.19	RGOCH0406	\$20.98	RGOCH0406	\$26.21	RGOCH0406

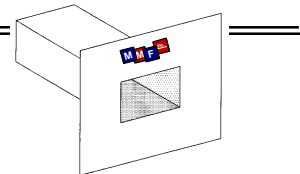

Bonderized

SIZE	LIST PRICE	PART NUMBER	LIST PRICE	PART NUMBER
	28 GA		26 GA	
2 x 3	\$13.66	RGOCHH0203	\$17.16	RGOCHH0203
2 x 4	\$22.36	RGOCHH0204	\$26.28	RGOCHH0204
3 x 4	\$16.12	RGOCHH0304	\$20.28	RGOCHH0304
4 x 6	\$18.58	RGOCHH0406	\$23.26	RGOCHH0406

ADVISORY: When installing product, Apply Sealant when/where necessary.

Multi: _____

7/1/09

10C-15



Louver Mounting Flanges

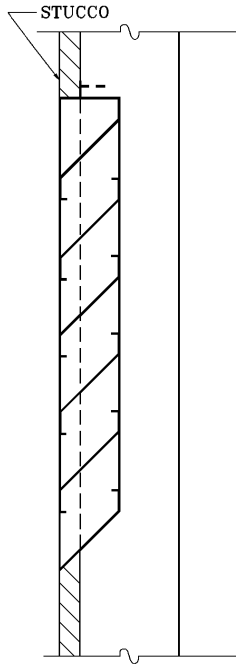

PLASTER GROUND (PG)

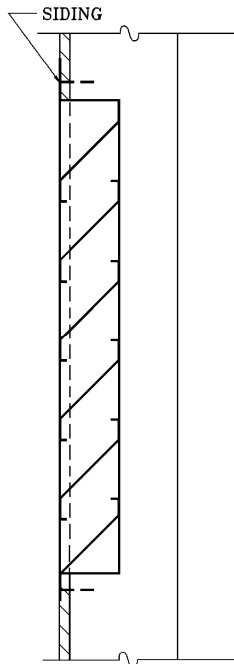

FLANGE ON FRONT (FOF)

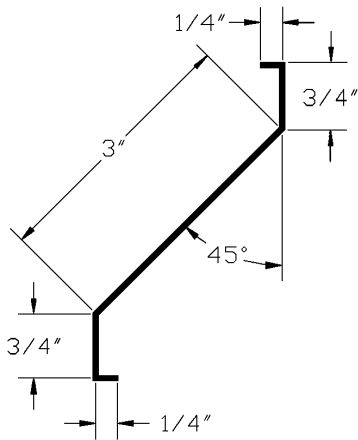
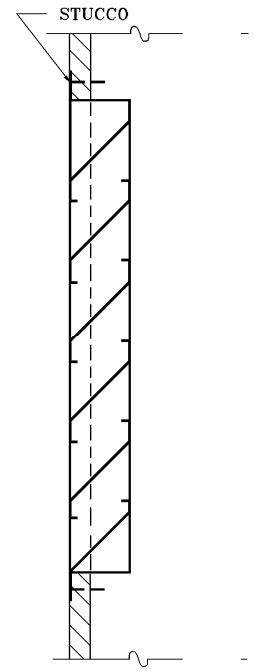

Blade Detail

ADVISORY: When installing product, Apply Sealant when/where necessary.

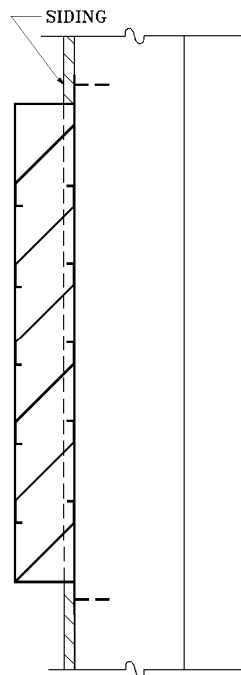

FLANGE ON BACK (FOB)

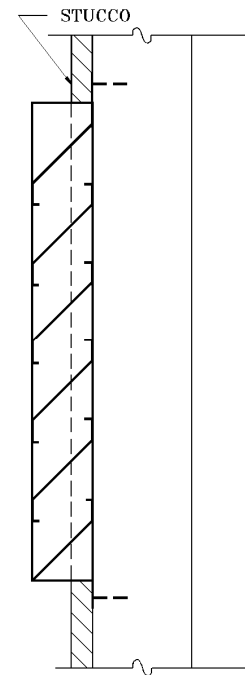

7/1/09

11C-SPECS



MODULAR METAL FABRICATORS INC.

Square Top Louvers - 28 Gauge

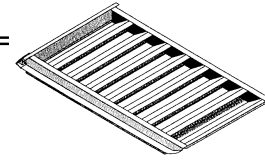

GALVANIZED

SIZE	LIST PRICE PG	PART NUMBER	LIST PRICE FF/FOB	PART NUMBER	
				FLANGE ON FRONT	FLANGE ON BACK
14 x 9	\$8.53	FLS1409HQF	\$9.46	FLS1409HQF	FLS1409HQB
14 x 12	\$8.98	FLS1412HQF	\$10.02	FLS1412HQF	FLS1412HQB
14 x 18	\$11.41	FLS1418HQF	\$12.66	FLS1418HQF	FLS1418HQB
14 x 24	\$15.60	FLS1424HQF	\$16.88	FLS1424HQF	FLS1424HQB
14 x 30	\$23.58	FLS1430HQF	\$25.38	FLS1430HQF	FLS1430HQB
14 x 36	\$28.29	FLS1436HQF	\$31.41	FLS1436HQF	FLS1436HQB
14 x 48	\$40.18	FLS1448HQF	\$44.58	FLS1448HQF	FLS1448HQB
18 x 18	\$40.94	FLS1818HQF	\$40.94	FLS1818HQF	FLS1818HQB
18 x 24	\$54.53	FLS1824HQF	\$54.53	FLS1824HQF	FLS1824HQB
18 x 30	\$73.04	FLS1830HQF	\$73.04	FLS1830HQF	FLS1830HQB
18 x 36	\$81.85	FLS1836HQF	\$81.85	FLS1836HQF	FLS1836HQB
18 x 60	\$136.69	FLS1860HQF	\$136.69	FLS1860HQF	FLS1860HQB
18 x 80	\$182.59	FLS1880HQF	\$182.59	FLS1880HQF	FLS1880HQB
24 x 18	\$54.53	FLS2418HQF	\$54.53	FLS2418HQF	FLS2418HQB
24 x 24	\$72.73	FLS2424HQF	\$72.73	FLS2424HQF	FLS2424HQB
24 x 30	\$90.79	FLS2430HQF	\$90.79	FLS2430HQF	FLS2430HQB
24 x 36	\$101.37	FLS2436HQF	\$101.37	FLS2436HQF	FLS2436HQB
24 x 42	\$123.17	FLS2442HQF	\$123.17	FLS2442HQF	FLS2442HQB
24 x 48	\$140.74	FLS2448HQF	\$140.74	FLS2448HQF	FLS2448HQB
30 x 24	\$90.66	FLS3024HQF	\$90.66	FLS3024HQF	FLS3024HQB
30 x 30	\$113.46	FLS3030HQF	\$113.46	FLS3030HQF	FLS3030HQB
36 x 36	\$163.31	FLS3636HQF	\$163.31	FLS3636HQF	FLS3636HQB
48 x 36	\$217.02	FLS4836HQF	\$217.02	FLS4836HQF	FLS4836HQB

BONDERIZED

SIZE	LIST PRICE PG	PART NUMBER	LIST PRICE SIZE	PART NUMBER	
				FLANGE ON FRONT	FLANGE ON BACK
14 x 9	\$8.66	FLS1409HHQF	\$9.64	FLS1409HHQF	FLS1409HHQB
14 x 12	\$9.70	FLS1412HHQF	\$10.78	FLS1412HHQF	FLS1412HHQB
14 x 18	\$11.75	FLS1418HHQF	\$13.52	FLS1418HHQF	FLS1418HHQB
14 x 24	\$15.98	FLS1424HHQF	\$18.75	FLS1424HHQF	FLS1424HHQB
14 x 30	\$24.65	FLS1430HHQF	\$33.60	FLS1430HHQF	FLS1430HHQB
14 x 36	\$30.54	FLS1436HHQF	\$33.90	FLS1436HHQF	FLS1436HHQB
14 x 48	\$41.15	FLS1448HHQF	\$45.69	FLS1448HHQF	FLS1448HHQB
18 x 18	\$45.38	FLS1818HHQF	\$45.38	FLS1818HHQF	FLS1818HHQB
18 x 24	\$60.46	FLS1824HHQF	\$60.46	FLS1824HHQF	FLS1824HHQB
18 x 30	\$81.05	FLS1830HHQF	\$81.05	FLS1830HHQF	FLS1830HHQB
18 x 36	\$90.76	FLS1836HHQF	\$90.76	FLS1836HHQF	FLS1836HHQB
18 x 60	\$151.60	FLS1860HHQF	\$151.60	FLS1860HHQF	FLS1860HHQB
18 x 80	\$201.58	FLS1880HHQF	\$201.58	FLS1880HHQF	FLS1880HHQB
24 x 18	\$60.46	FLS2418HHQF	\$60.46	FLS2418HHQF	FLS2418HHQB
24 x 24	\$80.60	FLS2424HHQF	\$80.60	FLS2424HHQF	FLS2424HHQB
24 x 30	\$100.70	FLS2430HHQF	\$100.70	FLS2430HHQF	FLS2430HHQB
24 x 36	\$120.88	FLS2436HHQF	\$120.88	FLS2436HHQF	FLS2436HHQB
24 x 42	\$136.86	FLS2442HHQF	\$136.86	FLS2442HHQF	FLS2442HHQB
24 x 48	\$156.42	FLS2448HHQF	\$156.42	FLS2448HHQF	FLS2448HHQB
30 x 24	\$91.52	FLS3024HHQF	\$91.52	FLS3024HHQF	FLS3024HHQB
30 x 30	\$125.98	FLS3030HHQF	\$125.98	FLS3030HHQF	FLS3030HHQB
36 x 36	\$181.34	FLS3636HHQF	\$181.34	FLS3636HHQF	FLS3636HHQB
48 x 36	\$237.19	FLS4836HHQF	\$237.19	FLS4836HHQF	FLS4836HHQB

5 PER BUNDLE.

NO BROKEN BUNDLES PLEASE.

**** NOTICE ****
Catalog pricing is based on a "standard pack" quantity.

Non "standard pack" quantity orders may be subject to an additional charge.

ADVISORY: When installing product, Apply Sealant when/where necessary.

Multi: _____

7/1/09

12C-08



MODULAR METAL FABRICATORS INC.

1/4 Tri Louver 4/12 Pitch - 28 Gauge

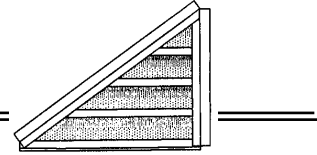

SIZE	LIST PRICE GALV.	PART NUMBER			LIST PRICE BOND.	PART NUMBER		
		PG	FF	FOB		PG	FF	FOB
12 x 12	\$30.34	FLK1212HQ	FLK1212HQ	FLK1212HQ	\$33.56	FLK1212HHQ	FLK1212HHQ	FLK1212HHQ
14 x 14	\$35.26	FLK1414HQ	FLK1414HQ	FLK1414HQ	\$39.21	FLK1414HHQ	FLK1414HHQ	FLK1414HHQ
18 x 18	\$45.38	FLK1818HQ	FLK1818HQ	FLK1818HQ	\$50.26	FLK1818HHQ	FLK1818HHQ	FLK1818HHQ
20 x 20	\$50.34	FLK2020HQ	FLK2020HQ	FLK2020HQ	\$55.88	FLK2020HHQ	FLK2020HHQ	FLK2020HHQ
24 x 24	\$60.39	FLK2424HQ	FLK2424HQ	FLK2424HQ	\$67.01	FLK2424HHQ	FLK2424HHQ	FLK2424HHQ
30 x 30	\$75.30	FLK3030HQ	FLK3030HQ	FLK3030HQ	\$83.90	FLK3030HHQ	FLK3030HHQ	FLK3030HHQ
36 x 36	\$90.72	FLK3636HQ	FLK3636HQ	FLK3636HQ	\$100.98	FLK3636HHQ	FLK3636HHQ	FLK3636HHQ
40 x 40	\$116.38	FLK4040HQ	FLK4040HQ	FLK4040HQ	\$130.07	FLK4040HHQ	FLK4040HHQ	FLK4040HHQ
48 x 48	\$139.67	FLK4848HQ	FLK4848HQ	FLK4848HQ	\$155.10	FLK4848HHQ	FLK4848HHQ	FLK4848HHQ
54 x 54	\$166.37	FLK5454HQ	FLK5454HQ	FLK5454HQ	\$184.78	FLK5454HHQ	FLK5454HHQ	FLK5454HHQ
60 x 60	\$184.74	FLK6060HQ	FLK6060HQ	FLK6060HQ	\$205.26	FLK6060HHQ	FLK6060HHQ	FLK6060HHQ
72 x 72	\$221.83	FLK7272HQ	FLK7272HQ	FLK7272HQ	\$246.14	FLK7272HHQ	FLK7272HHQ	FLK7272HHQ

Must State Right or Left When Ordering

1/4 Radius Louver - 28 Gauge

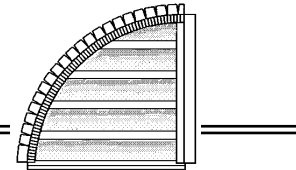

SIZE	LIST PRICE GALV.	PART NUMBER			LIST PRICE BOND.	PART NUMBER		
		PG	FF	FOB		PG	FF	FOB
12 x 12	\$30.34	FLL1212HQ	FLL1212HQ	FLL1212HQ	\$33.56	FLL1212HHQ	FLL1212HHQ	FLL1212HHQ
14 x 14	\$35.26	FLL1414HQ	FLL1414HQ	FLL1414HQ	\$39.21	FLL1414HHQ	FLL1414HHQ	FLL1414HHQ
18 x 18	\$45.38	FLL1818HQ	FLL1818HQ	FLL1818HQ	\$50.26	FLL1818HHQ	FLL1818HHQ	FLL1818HHQ
20 x 20	\$50.34	FLL2020HQ	FLL2020HQ	FLL2020HQ	\$55.88	FLL2020HHQ	FLL2020HHQ	FLL2020HHQ
24 x 24	\$60.39	FLL2424HQ	FLL2424HQ	FLL2424HQ	\$67.01	FLL2424HHQ	FLL2424HHQ	FLL2424HHQ
30 x 30	\$75.30	FLL3030HQ	FLL3030HQ	FLL3030HQ	\$83.90	FLL3030HHQ	FLL3030HHQ	FLL3030HHQ
36 x 36	\$90.72	FLL3636HQ	FLL3636HQ	FLL3636HQ	\$100.98	FLL3636HHQ	FLL3636HHQ	FLL3636HHQ
40 x 40	\$116.38	FLL4040HQ	FLL4040HQ	FLL4040HQ	\$130.07	FLL4040HHQ	FLL4040HHQ	FLL4040HHQ
48 x 48	\$139.67	FLL4848HQ	FLL4848HQ	FLL4848HQ	\$155.10	FLL4848HHQ	FLL4848HHQ	FLL4848HHQ
54 x 54	\$166.37	FLL5454HQ	FLL5454HQ	FLL5454HQ	\$184.78	FLL5454HHQ	FLL5454HHQ	FLL5454HHQ
60 x 60	\$184.74	FLL6060HQ	FLL6060HQ	FLL6060HQ	\$205.26	FLL6060HHQ	FLL6060HHQ	FLL6060HHQ
72 x 72	\$221.83	FLL7272HQ	FLL7272HQ	FLL7272HQ	\$246.14	FLL7272HHQ	FLL7272HHQ	FLL7272HHQ

Must State Right or Left When Ordering

**** NOTICE **** Catalog pricing is based on a "standard pack" quantity. Non "standard pack" quantity orders may be subject to an additional charge.

ADVISORY: When installing product, Apply Sealant when/where necessary.

Multi: _____

7/1/09

13C-08



MODULAR METAL FABRICATORS INC.

Triangle Louvers 4/12 Pitch - 28 Gauge

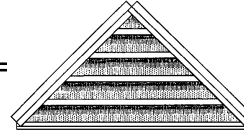

SIZE	LIST PRICE GALV.	PART NUMBER			LIST PRICE BOND.	PART NUMBER		
		PG	FF	FOB		PG	FF	FOB
24"	\$46.25	FLT24HQP	FLT24HQF	FLT24HQB	\$47.77	FLT24HHQP	FLT24HHQF	FLT24HHQB
30"	\$68.33	FLT30HQP	FLT30HQF	FLT30HQB	\$70.51	FLT30HHQP	FLT30HHQF	FLT30HHQB
36"	\$97.90	FLT36HQP	FLT36HQF	FLT36HQB	\$101.33	FLT36HHQP	FLT36HHQF	FLT36HHQB
42"	\$119.46	FLT42HQP	FLT42HQF	FLT42HQB	\$121.86	FLT42HHQP	FLT42HHQF	FLT42HHQB
48"	\$139.33	FLT48HQP	FLT48HQF	FLT48HQB	\$142.93	FLT48HHQP	FLT48HHQF	FLT48HHQB
60"	\$167.26	FLT60HQP	FLT60HQF	FLT60HQB	\$172.36	FLT60HHQP	FLT60HHQF	FLT60HHQB
72"	\$194.03	FLT72HQP	FLT72HQF	FLT72HQB	\$199.92	FLT72HHQP	FLT72HHQF	FLT72HHQB
84"	\$227.31	FLT84HQP	FLT84HQF	FLT84HQB	\$252.17	FLT84HHQP	FLT84HHQF	FLT84HHQB
96"	\$259.69	FLT96HQP	FLT96HQF	FLT96HQB	\$288.26	FLT96HHQP	FLT96HHQF	FLT96HHQB
108"	\$321.78	FLT108HQP	FLT108HQF	FLT108HQB	\$338.55	FLT108HHQP	FLT108HHQF	FLT108HHQB
120"	\$462.14	FLT120HQP	FLT120HQF	FLT120HQB	\$513.00	FLT120HHQP	FLT120HHQF	FLT120HHQB

Hexagon Louvers - 28 Gauge

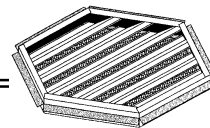

SIZE	LIST PRICE GALV.	PART NUMBER			LIST PRICE BOND.	PART NUMBER		
		PG	FF	FOB		PG	FF	FOB
12"	\$41.08	FLH12HQP	FLH12HQF	FLH12HQB	\$45.73	FLH12HHQP	FLH12HHQF	FLH12HHQB
14"	\$47.91	FLH14HQP	FLH14HQF	FLH14HQB	\$53.22	FLH14HHQP	FLH14HHQF	FLH14HHQB
16"	\$54.78	FLH16HQP	FLH16HQF	FLH16HQB	\$60.77	FLH16HHQP	FLH16HHQF	FLH16HHQB
18"	\$61.67	FLH18HQP	FLH18HQF	FLH18HQB	\$68.40	FLH18HHQP	FLH18HHQF	FLH18HHQB
20"	\$68.46	FLH20HQP	FLH20HQF	FLH20HQB	\$75.99	FLH20HHQP	FLH20HHQF	FLH20HHQB
24"	\$82.16	FLH24HQP	FLH24HQF	FLH24HQB	\$91.21	FLH24HHQP	FLH24HHQF	FLH24HHQB
30"	\$98.77	FLH30HQP	FLH30HQF	FLH30HQB	\$114.02	FLH30HHQP	FLH30HHQF	FLH30HHQB
36"	\$123.24	FLH36HQP	FLH36HQF	FLH36HQB	\$136.79	FLH36HHQP	FLH36HHQF	FLH36HHQB
48"	\$164.23	FLH48HQP	FLH48HQF	FLH48HQB	\$182.38	FLH48HHQP	FLH48HHQF	FLH48HHQB

Octagon Louvers - 28 Gauge

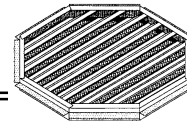

SIZE	LIST PRICE GALV.	PART NUMBER			LIST PRICE BOND.	PART NUMBER		
		PG	FF	FOB		PG	FF	FOB
12"	\$41.08	FLO12HQP	FLO12HQF	FLO12HQB	\$53.25	FLO12HHQP	FLO12HHQF	FLO12HHQB
14"	\$54.78	FLO14HQP	FLO14HQF	FLO14HQB	\$60.94	FLO14HHQP	FLO14HHQF	FLO14HHQB
16"	\$61.60	FLO16HQP	FLO16HQF	FLO16HQB	\$68.62	FLO16HHQP	FLO16HHQF	FLO16HHQB
18"	\$68.46	FLO18HQP	FLO18HQF	FLO18HQB	\$75.99	FLO18HHQP	FLO18HHQF	FLO18HHQB
20"	\$75.30	FLO20HQP	FLO20HQF	FLO20HQB	\$83.72	FLO20HHQP	FLO20HHQF	FLO20HHQB
24"	\$88.99	FLO24HQP	FLO24HQF	FLO24HQB	\$98.88	FLO24HHQP	FLO24HHQF	FLO24HHQB
26"	\$95.86	FLO26HQP	FLO26HQF	FLO26HQB	\$106.11	FLO26HHQP	FLO26HHQF	FLO26HHQB
30"	\$109.54	FLO30HQP	FLO30HQF	FLO30HQB	\$121.71	FLO30HHQP	FLO30HHQF	FLO30HHQB
36"	\$130.07	FLO36HQP	FLO36HQF	FLO36HQB	\$144.38	FLO36HHQP	FLO36HHQF	FLO36HHQB
48"	\$171.15	FLO48HQP	FLO48HQF	FLO48HQB	\$190.01	FLO48HHQP	FLO48HHQF	FLO48HHQB

ADVISORY: When installing product, Apply Sealant when/where necessary.

Multi: _____

7/1/09

14C-08



MODULAR METAL FABRICATORS INC.

Round Louver - 28 Gauge

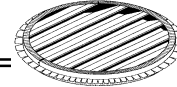

SIZE	LIST PRICE GALV.	PART NUMBER			LIST PRICE BOND.	PART NUMBER		
		PG	FF	FOB		PG	FF	FOB
12"	\$37.65	FLR12HQP	FLR12HQF	FLR12HQB	\$38.62	FLR12HHQP	FLR12HHQF	FLR12HHQB
14"	\$40.59	FLR14HQP	FLR14HQF	FLR14HQB	\$42.12	FLR14HHQP	FLR14HHQF	FLR14HHQB
16"	\$44.51	FLR16HQP	FLR16HQF	FLR16HQB	\$45.66	FLR16HHQP	FLR16HHQF	FLR16HHQB
18"	\$47.08	FLR18HQP	FLR18HQF	FLR18HQB	\$50.86	FLR18HHQP	FLR18HHQF	FLR18HHQB
20"	\$63.82	FLR20HQP	FLR20HQF	FLR20HQB	\$68.98	FLR20HHQP	FLR20HHQF	FLR20HHQB
24"	\$80.98	FLR24HQP	FLR24HQF	FLR24HQB	\$84.21	FLR24HHQP	FLR24HHQF	FLR24HHQB
30"	\$102.68	FLR30HQP	FLR30HQF	FLR30HQB	\$105.28	FLR30HHQP	FLR30HHQF	FLR30HHQB
36"	\$116.38	FLR36HQP	FLR36HQF	FLR36HQB	\$119.32	FLR36HHQP	FLR36HHQF	FLR36HHQB
42"	\$143.76	FLR42HQP	FLR42HQF	FLR42HQB	\$147.19	FLR42HHQP	FLR42HHQF	FLR42HHQB
48"	\$164.32	FLR48HQP	FLR48HQF	FLR48HQB	\$168.41	FLR48HHQP	FLR48HHQF	FLR48HHQB
52"	\$178.02	FLR52HQP	FLR52HQF	FLR52HQB	\$183.49	FLR52HHQP	FLR52HHQF	FLR52HHQB
60"	\$205.40	FLR60HQP	FLR60HQF	FLR60HQB	\$210.53	FLR60HHQP	FLR60HHQF	FLR60HHQB
72"	\$246.48	FLR72HQP	FLR72HQF	FLR72HQB	\$251.61	FLR72HHQP	FLR72HHQF	FLR72HHQB

1/2 Round Louver - 28 Gauge



SIZE	LIST PRICE GALV.	PART NUMBER			LIST PRICE BOND.	PART NUMBER		
		PG	FF	FOB		PG	FF	FOB
12"	\$32.62	FLB12HQP	FLB12HQF	FLB12HQB	\$34.74	FLB12HHQP	FLB12HHQF	FLB12HHQB
14"	\$35.81	FLB14HQP	FLB14HQF	FLB14HQB	\$36.37	FLB14HHQP	FLB14HHQF	FLB14HHQB
16"	\$37.72	FLB16HQP	FLB16HQF	FLB16HQB	\$39.45	FLB16HHQP	FLB16HHQF	FLB16HHQB
18"	\$40.65	FLB18HQP	FLB18HQF	FLB18HQB	\$41.74	FLB18HHQP	FLB18HHQF	FLB18HHQB
20"	\$43.47	FLB20HQP	FLB20HQF	FLB20HQB	\$45.00	FLB20HHQP	FLB20HHQF	FLB20HHQB
24"	\$46.25	FLB24HQP	FLB24HQF	FLB24HQB	\$47.84	FLB24HHQP	FLB24HHQF	FLB24HHQB
30"	\$68.36	FLB30HQP	FLB30HQF	FLB30HQB	\$70.65	FLB30HHQP	FLB30HHQF	FLB30HHQB
36"	\$98.00	FLB36HQP	FLB36HQF	FLB36HQB	\$101.16	FLB36HHQP	FLB36HHQF	FLB36HHQB
42"	\$119.50	FLB42HQP	FLB42HQF	FLB42HQB	\$121.96	FLB42HHQP	FLB42HHQF	FLB42HHQB
48"	\$138.91	FLB48HQP	FLB48HQF	FLB48HQB	\$142.82	FLB48HHQP	FLB48HHQF	FLB48HHQB
52"	\$155.62	FLB52HQP	FLB52HQF	FLB52HQB	\$159.98	FLB52HHQP	FLB52HHQF	FLB52HHQB
60"	\$167.20	FLB60HQP	FLB60HQF	FLB60HQB	\$172.30	FLB60HHQP	FLB60HHQF	FLB60HHQB
72"	\$194.10	FLB72HQP	FLB72HQF	FLB72HQB	\$199.92	FLB72HHQP	FLB72HHQF	FLB72HHQB

Clover Leaf Louver - 28 Gauge

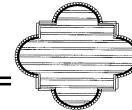

SIZE	LIST PRICE GALV.	PART NUMBER			LIST PRICE BOND.	PART NUMBER		
		PG	FF	FOB		PG	FF	FOB
18 x 18	\$111.07	FLC1818HQP	FLC1818HQF	FLC1818HQB	\$123.10	FLC1818HHQP	FLC1818HHQF	FLC1818HHQB
24 x 24	\$147.98	FLC2424HQP	FLC2424HQF	FLC2424HQB	\$164.18	FLC2424HHQP	FLC2424HHQF	FLC2424HHQB
30 x 30	\$184.84	FLC3030HQP	FLC3030HQF	FLC3030HQB	\$205.22	FLC3030HHQP	FLC3030HHQF	FLC3030HHQB
36 x 36	\$221.83	FLC3636HQP	FLC3636HQF	FLC3636HQB	\$246.24	FLC3636HHQP	FLC3636HHQF	FLC3636HHQB
48 x 48	\$295.78	FLC4848HQP	FLC4848HQF	FLC4848HQB	\$328.30	FLC4848HHQP	FLC4848HHQF	FLC4848HHQB
60 x 60	\$369.72	FLC6060HQP	FLC6060HQF	FLC6060HQB	\$410.38	FLC6060HHQP	FLC6060HHQF	FLC6060HHQB
72 x 72	\$443.66	FLC7272HQP	FLC7272HQF	FLC7272HQB	\$492.47	FLC7272HHQP	FLC7272HHQF	FLC7272HHQB
84 x 84	\$517.61	FLC8484HQP	FLC8484HQF	FLC8484HQB	\$574.57	FLC8484HHQP	FLC8484HHQF	FLC8484HHQB

Multi:

ADVISORY: When installing product, Apply Sealant when/where necessary.

7/1/09

15C-08



MODULAR METAL FABRICATORS INC.

1/2 Round Top Louver - 28 Gauge

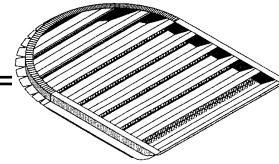

SIZE	LIST PRICE	PART NUMBER			LIST PRICE	PART NUMBER		
	GALV.	PG	FF	FOB	BOND.	PG	FF	FOB
14 x 18	\$31.69	FLN1418HQP	FLN1418HQF	FLN1418HQB	\$32.94	FLN1418HHQP	FLN1418HHQF	FLN1418HHQB
14 x 24	\$38.93	FLN1424HQP	FLN1424HQF	FLN1424HQB	\$40.74	FLN1424HHQP	FLN1424HHQF	FLN1424HHQB
14 x 30	\$50.72	FLN1430HQP	FLN1430HQF	FLN1430HQB	\$53.28	FLN1430HHQP	FLN1430HHQF	FLN1430HHQB
14 x 36	\$56.92	FLN1436HQP	FLN1436HQF	FLN1436HQB	\$59.83	FLN1436HHQP	FLN1436HHQF	FLN1436HHQB
14 x 42	\$64.55	FLN1442HQP	FLN1442HQF	FLN1442HQB	\$71.66	FLN1442HHQP	FLN1442HHQF	FLN1442HHQB
18 x 24	\$53.38	FLN1824HQP	FLN1824HQF	FLN1824HQB	\$59.31	FLN1824HHQP	FLN1824HHQF	FLN1824HHQB
18 x 36	\$80.15	FLN1836HQP	FLN1836HQF	FLN1836HQB	\$88.99	FLN1836HHQP	FLN1836HHQF	FLN1836HHQB
24 x 30	\$88.99	FLN2430HQP	FLN2430HQF	FLN2430HQB	\$98.83	FLN2430HHQP	FLN2430HHQF	FLN2430HHQB
24 x 36	\$106.81	FLN2436HQP	FLN2436HQF	FLN2436HQB	\$118.46	FLN2436HHQP	FLN2436HHQF	FLN2436HHQB
24 x 42	\$124.66	FLN2442HQP	FLN2442HQF	FLN2442HQB	\$138.39	FLN2442HHQP	FLN2442HHQF	FLN2442HHQB
30 x 42	\$155.79	FLN3042HQP	FLN3042HQF	FLN3042HQB	\$172.98	FLN3042HHQP	FLN3042HHQF	FLN3042HHQB
36 x 30	\$133.54	FLN3630HQP	FLN3630HQF	FLN3630HQB	\$152.08	FLN3630HHQP	FLN3630HHQF	FLN3630HHQB
36 x 36	\$152.67	FLN3636HQP	FLN3636HQF	FLN3636HQB	\$169.66	FLN3636HHQP	FLN3636HHQF	FLN3636HHQB

1/2 Radius Top Louver - 28 Gauge

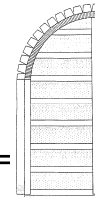

SIZE	LIST PRICE	PART NUMBER			LIST PRICE	PART NUMBER		
	GALV.	PG	FF	FOB	BOND.	PG	FF	FOB
14 x 18	\$35.95	FLM1418HQP	FLM1418HQF	FLM1418HQB	\$37.26	FLM1418HHQP	FLM1418HHQF	FLM1418HHQB
14 x 24	\$47.92	FLM1424HQP	FLM1424HQF	FLM1424HQB	\$53.07	FLM1424HHQP	FLM1424HHQF	FLM1424HHQB
14 x 30	\$61.60	FLM1430HQP	FLM1430HQF	FLM1430HQB	\$66.77	FLM1430HHQP	FLM1430HHQF	FLM1430HHQB
14 x 36	\$77.03	FLM1436HQP	FLM1436HQF	FLM1436HQB	\$82.26	FLM1436HHQP	FLM1436HHQF	FLM1436HHQB
14 x 48	\$128.03	FLM1448HQP	FLM1448HQF	FLM1448HQB	\$137.21	FLM1448HHQP	FLM1448HHQF	FLM1448HHQB
24 x 24	\$67.98	FLM2424HQP	FLM2424HQF	FLM2424HQB	\$88.16	FLM2424HHQP	FLM2424HHQF	FLM2424HHQB
24 x 30	\$84.90	FLM2430HQP	FLM2430HQF	FLM2430HQB	\$94.33	FLM2430HHQP	FLM2430HHQF	FLM2430HHQB
24 x 36	\$119.11	FLM2436HQP	FLM2436HQF	FLM2436HQB	\$127.45	FLM2436HHQP	FLM2436HHQF	FLM2436HHQB
24 x 48	\$135.75	FLM2448HQP	FLM2448HQF	FLM2448HQB	\$150.62	FLM2448HHQP	FLM2448HHQF	FLM2448HHQB
36 x 36	\$154.06	FLM3636HQP	FLM3636HQF	FLM3636HQB	\$169.80	FLM3636HHQP	FLM3636HHQF	FLM3636HHQB
36 x 48	\$203.60	FLM3648HQP	FLM3648HQF	FLM3648HQB	\$225.92	FLM3648HHQP	FLM3648HHQF	FLM3648HHQB
36 x 60	\$254.52	FLM3660HQP	FLM3660HQF	FLM3660HQB	\$282.60	FLM3660HHQP	FLM3660HHQF	FLM3660HHQB
36 x 72	\$305.55	FLM3672HQP	FLM3672HQF	FLM3672HQB	\$340.63	FLM3672HHQP	FLM3672HHQF	FLM3672HHQB

Must Specify Right or Left When Ordering

ADVISORY: When installing product,
Apply Sealant when/where necessary.

Multi: _____

7/1/09

16C-08



MODULAR METAL FABRICATORS INC.

Triangle Top - 28 Gauge - 4/12 Pitch

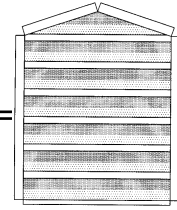

SIZE	LIST PRICE	PART NUMBER			LIST PRICE	PART NUMBER		
	GALV.	PG	FF	FOB	BOND.	PG	FF	FOB
14 x 18	\$32.62	FLW1418HQP	FLW1418HQF	FLW1418HQB	\$34.22	FLW1418HHQP	FLW1418HHQF	FLW1418HHQB
14 x 24	\$39.70	FLW1424HQP	FLW1424HQF	FLW1424HQB	\$42.36	FLW1424HHQP	FLW1424HHQF	FLW1424HHQB
14 x 30	\$51.34	FLW1430HQP	FLW1430HQF	FLW1430HQB	\$55.22	FLW1430HHQP	FLW1430HHQF	FLW1430HHQB
14 x 36	\$57.69	FLW1436HQP	FLW1436HQF	FLW1436HQB	\$62.16	FLW1436HHQP	FLW1436HHQF	FLW1436HHQB
14 x 48	\$71.90	FLW1448HQP	FLW1448HQF	FLW1448HQB	\$82.09	FLW1448HHQP	FLW1448HHQF	FLW1448HHQB
18 x 24	\$53.38	FLW1824HQP	FLW1824HQF	FLW1824HQB	\$59.31	FLW1824HHQP	FLW1824HHQF	FLW1824HHQB
18 x 30	\$66.94	FLW1830HQP	FLW1830HQF	FLW1830HQB	\$77.72	FLW1830HHQP	FLW1830HHQF	FLW1830HHQB
18 x 36	\$80.15	FLW1836HQP	FLW1836HQF	FLW1836HQB	\$88.99	FLW1836HHQP	FLW1836HHQF	FLW1836HHQB
18 x 48	\$110.42	FLW1848HQP	FLW1848HQF	FLW1848HQB	\$122.54	FLW1848HHQP	FLW1848HHQF	FLW1848HHQB
24 x 30	\$88.99	FLW2430HQP	FLW2430HQF	FLW2430HQB	\$98.83	FLW2430HHQP	FLW2430HHQF	FLW2430HHQB
24 x 36	\$106.81	FLW2436HQP	FLW2436HQF	FLW2436HQB	\$114.64	FLW2436HHQP	FLW2436HHQF	FLW2436HHQB
24 x 48	\$144.80	FLW2448HQP	FLW2448HQF	FLW2448HQB	\$161.93	FLW2448HHQP	FLW2448HHQF	FLW2448HHQB
36 x 36	\$152.67	FLW3636HQP	FLW3636HQF	FLW3636HQB	\$169.66	FLW3636HHQP	FLW3636HHQF	FLW3636HHQB
36 x 48	\$203.87	FLW3648HQP	FLW3648HQF	FLW3648HQB	\$236.57	FLW3648HHQP	FLW3648HHQF	FLW3648HHQB
36 x 60	\$256.74	FLW3660HQP	FLW3660HQF	FLW3660HQB	\$284.82	FLW3660HHQP	FLW3660HHQF	FLW3660HHQB
36 x 72	\$308.08	FLW3672HQP	FLW3672HQF	FLW3672HQB	\$341.98	FLW3672HHQP	FLW3672HHQF	FLW3672HHQB
48 x 60	\$466.62	FLW4860HQP	FLW4860HQF	FLW4860HQB	\$520.00	FLW4860HHQP	FLW4860HHQF	FLW4860HHQB
48 x 72	\$559.90	FLW4872HQP	FLW4872HQF	FLW4872HQB	\$623.03	FLW4872HHQP	FLW4872HHQF	FLW4872HHQB
48 x 84	\$634.30	FLW4884HQP	FLW4884HQF	FLW4884HQB	\$725.74	FLW4884HHQP	FLW4884HHQF	FLW4884HHQB

Access Louver - 28 Gauge - Removable

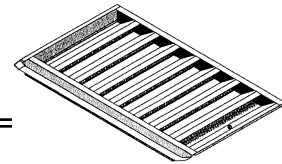

SIZE	LIST PRICE	PART NUMBER			LIST PRICE	PART NUMBER		
	GALV.	PG	FF	FOB	BOND.	PG	FF	FOB
18 x 24	\$52.24	FLA1824HQP	FLA1824HQF	FLA1824HQB	\$57.86	FLA1824HHQP	FLA1824HHQF	FLA1824HHQB
22 x 30	\$54.78	FLA2230HQP	FLA2230HQF	FLA2230HQB	\$60.77	FLA2230HHQP	FLA2230HHQF	FLA2230HHQB
24 x 24	\$69.16	FLA2424HQP	FLA2424HQF	FLA2424HQB	\$76.68	FLA2424HHQP	FLA2424HHQF	FLA2424HHQB
24 x 30	\$77.20	FLA2430HQP	FLA2430HQF	FLA2430HQB	\$85.59	FLA2430HHQP	FLA2430HHQF	FLA2430HHQB
30 x 18	\$64.24	FLA3018HQP	FLA3018HQF	FLA3018HQB	\$71.21	FLA3018HHQP	FLA3018HHQF	FLA3018HHQB
30 x 30	\$76.68	FLA3030HQP	FLA3030HQF	FLA3030HQB	\$82.86	FLA3030HHQP	FLA3030HHQF	FLA3030HHQB
36 x 30	\$80.11	FLA3630HQP	FLA3630HQF	FLA3630HQB	\$88.99	FLA3630HHQP	FLA3630HHQF	FLA3630HHQB
36 x 36	\$102.68	FLA3636HQP	FLA3636HQF	FLA3636HQB	\$116.38	FLA3636HHQP	FLA3636HHQF	FLA3636HHQB

ADVISORY: When installing product, Apply Sealant when/where necessary.

Multi: _____

7/1/09

17C-08



MODULAR METAL FABRICATORS INC.

1/2 Round Dormer Vent - 28 Gauge

SIZE	LIST PRICE GALV.	PART NUMBER	LIST PRICE BOND.	PART NUMBER
9 x 18	\$29.63	FLD0918HQ	\$32.98	FLD0918HHQ
12 x 24	\$36.20	FLD1224HQ	\$37.87	FLD1224HHQ

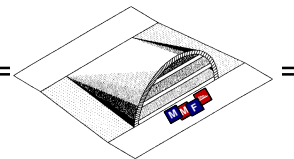

1/2 Round Dormer Vent - 28 Gauge

With Dead Soft Aluminum on Three Sides

SIZE	LIST PRICE GALV.	PART NUMBER	LIST PRICE BOND.	PART NUMBER
9 x 18	\$65.16	FLE0918HQ	\$72.60	FLE0918HHQ
12 x 24	\$77.01	FLE1224HQ	\$85.50	FLE1224HHQ

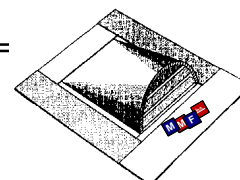

Combustion Vent - 28 Gauge

SIZE	LIST PRICE GALV.	PART NUMBER	LIST PRICE BOND.	PART NUMBER
#100	\$29.50	FLF100H	\$31.13	FLF100HH
#200	\$41.47	FLF200H	\$42.80	FLF200HH

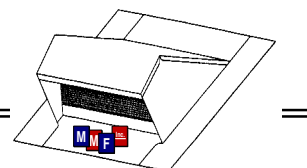

Combustion Vent - 28 Gauge

With Dead Soft Aluminum on Three Sides

SIZE	LIST PRICE GALV.	PART NUMBER	LIST PRICE BOND.	PART NUMBER
#100	\$79.00	FLG100H	\$87.73	FLG100HH
#200	\$88.87	FLG200H	\$98.60	FLG200HH

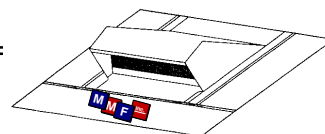

Flashing for 1/2 Round Dormer and Combustion Vent - 28 Gauge

SIZE	LIST PRICE GALV.	PART NUMBER	
		1/2 RND	COMBUSTION
#100 (9 x 18)	\$10.83	FLJ100HQ	FLI100HQ
#200 (12 x 24)	\$11.20	FLJ200HQ	FLI200HQ

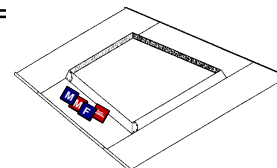

ADVISORY: When installing product, Apply Sealant when/where necessary.

Multi: _____

7/1/09

18C-08



MODULAR METAL FABRICATORS INC.

Curbs - See page 20C-03 for Cooler Flashings

Modular Metal Fabricators, Inc. manufactures high quality curbs per your customers specifications. Please call for pricing.

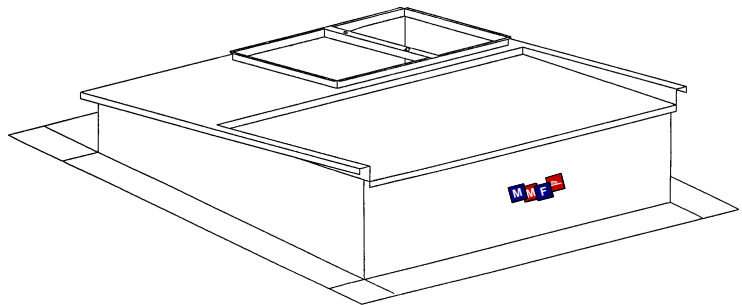
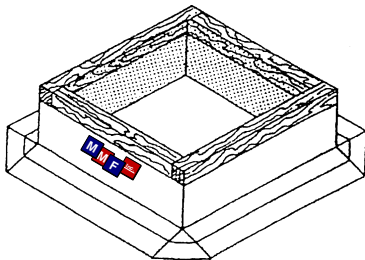
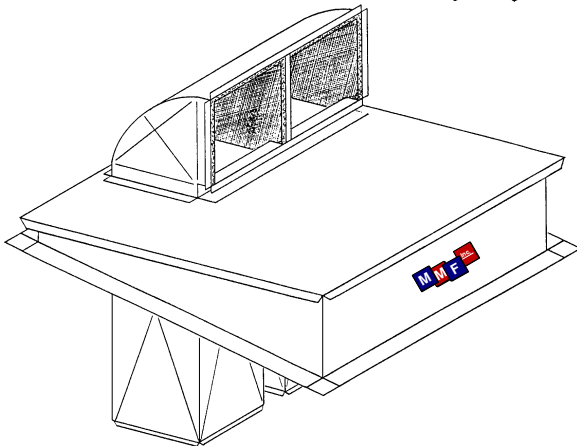
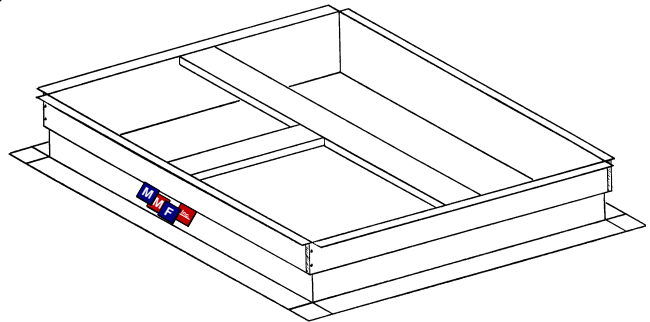
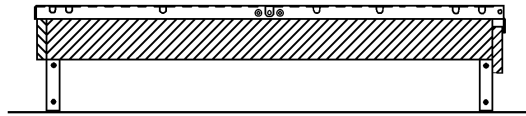
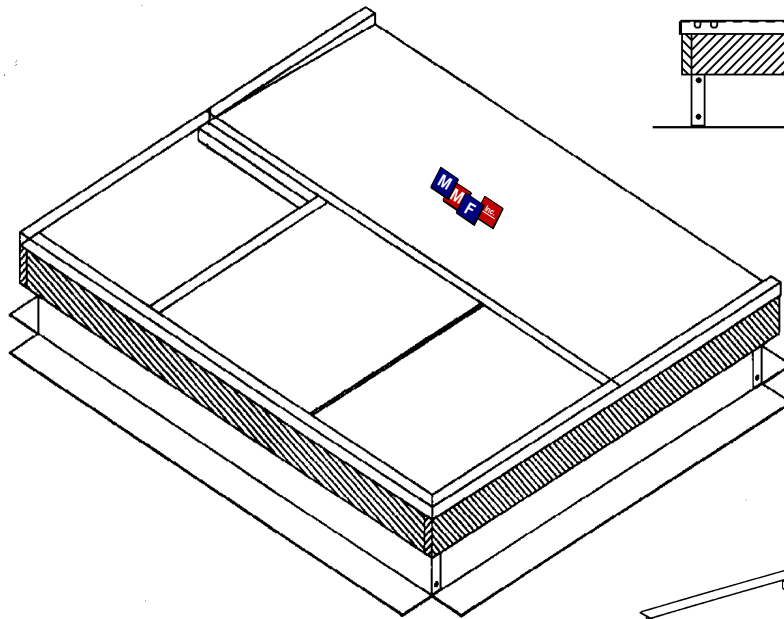

ADVISORY: When installing product,
Apply Sealant when/where necessary.

7/1/09

19C-00



MODULAR METAL FABRICATORS INC.

Cooler Flashing - Standard/Flat 6" High with 4" Skirt-Sealed

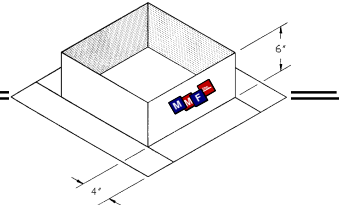

SIZE	LIST PRICE	PART NUMBER	LIST PRICE	PART NUMBER
	26 GA		24 GA	
13 1/2 x 13 1/2	\$29.63	FLCFICYCYS	\$35.83	FLCFJCYCYS
14 1/2 x 14 1/2	\$31.67	FLCFIDGDGS	\$38.30	FLCFJDGDGS
15 1/2 x 15 1/2	\$32.90	FLCFIDODOS	\$39.70	FLCFJDODOS
17 1/2 x 17 1/2	\$34.53	FLCFIEEEES	\$41.80	FLCFJEEES
18 1/2 x 18 1/2	\$35.57	FLCFIEMEMS	\$43.00	FLCFJEMEMS
19 1/2 x 19 1/2	\$36.50	FLCFIEUEUS	\$44.20	FLCFJEUUEUS
20 1/2 x 20 1/2	\$37.73	FLCFIFCFCS	\$45.67	FLCFJFCFCS
21 1/2 x 21 1/2	\$38.97	FLCFIFKFKS	\$47.13	FLCFJFKFKS
22 1/2 x 22 1/2	\$40.00	FLCFIFSFSS	\$48.40	FLCFJFSFSS

Cooler Flashing - Pitched (3/12, 4/12, 5/12) 4" Skirt-Sealed

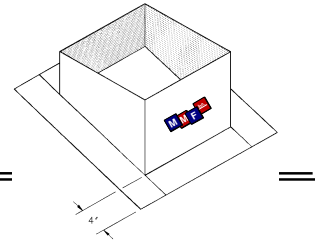

3/12 PITCH & 4/12 PITCH

SIZE	LIST PRICE 26 GA	PART NUMBER		LIST PRICE 24 GA	PART NUMBER	
		3/12 PITCH	4/12 PITCH		3/12 PITCH	4/12 PITCH
13 1/2 x 13 1/2	\$31.40	FLCP3ICYCYS	FLCP4ICYCYS	\$37.97	FLCP3JCYCYS	FLCP4JCYCYS
14 1/2 x 14 1/2	\$33.53	FLCP3IDGDGS	FLCP4IDGDGS	\$39.70	FLCP3JDGDGS	FLCP4JDGDGS
15 1/2 x 15 1/2	\$34.85	FLCP3IDODOS	FLCP4IDODOS	\$42.17	FLCP3JDODOS	FLCP4JDODOS
17 1/2 x 17 1/2	\$36.60	FLCP3IEEES	FLCP4IEEES	\$44.27	FLCP3JEEES	FLCP4JEEES
18 1/2 x 18 1/2	\$37.73	FLCP3IEMEMS	FLCP4IEMEMS	\$45.57	FLCP3JEMEMS	FLCP4JEMEMS
19 1/2 x 19 1/2	\$38.70	FLCP3IEUEUS	FLCP4IEUEUS	\$46.80	FLCP3JEUUEUS	FLCP4JEUUEUS
20 1/2 x 20 1/2	\$40.00	FLCP3IFCFCS	FLCP4IFCFCS	\$48.40	FLCP3JFCFCS	FLCP4JFCFCS
21 1/2 x 21 1/2	\$41.30	FLCP3IFKFKS	FLCP4IFKFKS	\$49.97	FLCP3JFKFKS	FLCP4JFKFKS
22 1/2 x 22 1/2	\$42.40	FLCP3IFSFS	FLCP4IFSFS	\$51.30	FLCP3JFSFS	FLCP4JFSFS

SIZE	LIST PRICE	PART NUMBER	LIST PRICE	PART NUMBER
	26 GA		24 GA	
13 1/2 x 13 1/2	\$34.54	FLCP5ICYCYS	\$41.77	FLCP5JCYCYS
14 1/2 x 14 1/2	\$36.88	FLCP5IDGDGS	\$43.67	FLCP5JDGDGS
15 1/2 x 15 1/2	\$38.34	FLCP5IDODOS	\$46.39	FLCP5JDODOS
17 1/2 x 17 1/2	\$40.26	FLCP5IEEES	\$48.70	FLCP5JEEES
18 1/2 x 18 1/2	\$41.50	FLCP5IEMEMS	\$50.13	FLCP5JEMEMS
19 1/2 x 19 1/2	\$42.57	FLCP5IEUEUS	\$51.48	FLCP5JEUUEUS
20 1/2 x 20 1/2	\$44.00	FLCP5IFCFCS	\$53.24	FLCP5JFCFCS
21 1/2 x 21 1/2	\$45.43	FLCP5IFKFKS	\$54.97	FLCP5JFKFKS
22 1/2 x 22 1/2	\$46.64	FLCP5IFSFS	\$56.43	FLCP5JFSFS

ADVISORY: When installing product, Apply Sealant when/where necessary.

Multi: _____

7/1/09

20C-03



MODULAR METAL FABRICATORS INC.

Cooler Flashing - Standard/Flat 6" High with 4" Skirt-Sealed-WITH CLIPS

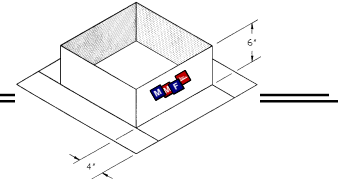

SIZE	LIST PRICE	WITH CLIPS PART NUMBER	LIST PRICE	WITH CLIPS PART NUMBER
	26 GA		24 GA	
13 1/2 x 13 1/2	\$39.31	FLCFICYCYSC	\$47.54	FLCFJCYCYSC
14 1/2 x 14 1/2	\$41.35	FLCFIDGDGSC	\$50.01	FLCFJDGDGSC
15 1/2 x 15 1/2	\$42.58	FLCFIDODOSC	\$51.41	FLCFJDODOSC
17 1/2 x 17 1/2	\$47.43	FLCFIEEEESC	\$57.41	FLCFJEEESC
18 1/2 x 18 1/2	\$48.47	FLCFIEMEMSC	\$58.61	FLCFJEMEMSC
19 1/2 x 19 1/2	\$49.40	FLCFIEUEUSC	\$59.81	FLCFJEUUSC
20 1/2 x 20 1/2	\$50.63	FLCFIFCFSC	\$61.28	FLCFJFCFCSC
21 1/2 x 21 1/2	\$55.10	FLCFIFKFKSC	\$66.65	FLCFJFKFKSC
22 1/2 x 22 1/2	\$56.13	FLCFIFSFSSC	\$67.92	FLCFJFSFSSC

Cooler Flashing - Pitched (3/12, 4/12, 5/12) 4" Skirt-Sealed-WITH CLIPS

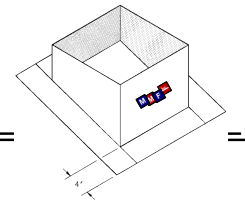

SIZE	LIST PRICE 26 GA	W-CLIPS	W-CLIPS	LIST PRICE 24 GA	W-CLIPS	W-CLIPS
		3/12 PITCH	4/12 PITCH		3/12 PITCH	4/12 PITCH
13 1/2 x 13 1/2	\$41.08	FLCP3ICYCYSC	FLCP4ICYCYSC	\$49.68	FLCP3JCYCYSC	FLCP4JCYCYSC
14 1/2 x 14 1/2	\$43.21	FLCP3IDGDGSC	FLCP4IDGDGSC	\$51.41	FLCP3JDGDGSC	FLCP4JDGDGSC
15 1/2 x 15 1/2	\$44.53	FLCP3IDODOSC	FLCP4IDODOSC	\$53.88	FLCP3JDODOSC	FLCP4JDODOSC
17 1/2 x 17 1/2	\$49.50	FLCP3IEEEESC	FLCP4IEEEESC	\$59.88	FLCP3JEEESC	FLCP4JEEESC
18 1/2 x 18 1/2	\$50.63	FLCP3IEMEMSC	FLCP4IEMEMSC	\$61.18	FLCP3JEMEMSC	FLCP4JEMEMSC
19 1/2 x 19 1/2	\$51.60	FLCP3IEUEUSC	FLCP4IEUEUSC	\$62.41	FLCP3JEUUSC	FLCP4JEUUSC
20 1/2 x 20 1/2	\$52.90	FLCP3IFCFSC	FLCP4IFCFSC	\$64.01	FLCP3JFCFCSC	FLCP4JFCFCSC
21 1/2 x 21 1/2	\$57.43	FLCP3IFKFKSC	FLCP4IFKFKSC	\$69.49	FLCP3JFKFKSC	FLCP4JFKFKSC
22 1/2 x 22 1/2	\$58.53	FLCP3IFSFS	FLCP4IFSFS	\$70.82	FLCP3JFSFS	FLCP4JFSFS

SIZE	LIST PRICE	W-CLIPS PART NUMBER	LIST PRICE	W-CLIPS PART NUMBER
	26 GA	5/12 PITCH	24 GA	5/12 PITCH
13 1/2 x 13 1/2	\$44.22	FLCP5ICYCYSC	\$53.48	FLCP5JCYCYSC
14 1/2 x 14 1/2	\$46.56	FLCP5IDGDGSC	\$55.38	FLCP5JDGDGSC
15 1/2 x 15 1/2	\$48.02	FLCP5IDODOSC	\$58.38	FLCP5JDODOSC
17 1/2 x 17 1/2	\$53.16	FLCP5IEEEESC	\$64.31	FLCP5JEEESC
18 1/2 x 18 1/2	\$54.40	FLCP5IEMEMSC	\$65.74	FLCP5JEMEMSC
19 1/2 x 19 1/2	\$55.47	FLCP5IEUEUSC	\$67.09	FLCP5JEUUSC
20 1/2 x 20 1/2	\$56.90	FLCP5IFCFSC	\$68.85	FLCP5JFCFCSC
21 1/2 x 21 1/2	\$61.56	FLCP5IFKFKSC	\$74.49	FLCP5JFKFKSC
22 1/2 x 22 1/2	\$62.77	FLCP5IFSFS	\$75.95	FLCP5JFSFS

ADVISORY: When installing product, Apply Sealant when/where necessary.

Multi: _____

7/1/09

20CC-03